



**ESEN**  
Elektrik San. ve Tic. Ltd. Şti.

 **QUICK**



 **FULLTECH®**



 **Auer Signal**



# 2025

Fiyat Listesi ve  
Ürün Kataloğu

**Physikalisch-Technische Bundesanstalt**  
Braunschweig und Berlin

**PTB**

**EG-Baumusterprüfbescheinigung**

(1) Geräte und Schutzsysteme zur bestimmungsgemäßen Verwendung in explosionsgefährdeten Bereichen - Richtlinie 94/9/EG

(2) DG-Baumusterprüfbescheinigungsnummer

**PTB 01 ATEX 1133**

Signatur Typ 0101 bzw. 0102

(4) Gerät: 2-Axial Filter elektronische Maschinen Gesellschaft mbH  
 (5) Hersteller: Seiberggasse 24, 1120 Wien, Österreich  
 (6) Arbeitsplatz

(7) Der Zweck dieses Gerätes sowie die vorzunehmenden notwendigen Ausschüßarbeiten sind in dem Sachverständigenprüfprotokoll festzulegen.

(8) Die Prüfmodalität, Technische Bauvorschriften, Besondere Bestimmungen, die im Anhang 1 der Richtlinie des Rates der Europäischen Gemeinschaften vom 23. März 1994 (1994/9/EG) zur Angleichung der Bauvorschriften und der Prüfverfahren für die Bauelemente von explosionsgeschützten Schutzsystemen für die bestimmungsgemäße Verwendung in explosionsgefährdeten Bereichen, Artikel 1 der Richtlinie.

(9) Das Ergebnis der Prüfung ist in dem vom Sachverständigen PTB Ex 01-1133 genehmigten Prüfprotokoll und dem Gutachten des Sachverständigen festzulegen.

(10) Die spezifizierten Schutzarten sind: **EN 50018:2000** **EN 50014:1997 + A1 + A2** **EN 50018:2000**

(11) Für die Zylinder "C" besteht die Beschleunigungsprüfung nicht, wird nur die sichere Anwendung des Gerätes nach der Anlage in dieser Bauvorschrift geprüft.

(12) Diese EG-Baumusterprüfbescheinigung beschränkt sich nur auf die Angaben des Herstellers. Die Bauvorschriften sind in der Anlage 1 der Richtlinie des Rates der Europäischen Gemeinschaften vom 23. März 1994 (1994/9/EG) festzulegen.

(13) Die Kennzeichnung des Gerätes muß die folgenden Angaben enthalten:

**CE** **Ex** **de** **IC** **T5**

Zustellungsstelle: Explanungsstelle  
 Unterschrift:   
 Dr. phil. habil.   
 Regierungsdirektor

**DMT**

**EC-Type Examination Certificate**

Translation

**Directive 94/9/EC -**  
Equipment and protective systems intended for use in potentially explosive atmospheres

**DMT 03 ATEX E 034**

Equipment: **Telephone Type 411**

Manufacturer: **2-Axial Filter elektronischer Maschinen GmbH**

Address: **A 1120 Wien**

(1) The design and construction of the equipment and any acceptable variation thereof are specified in the certificate and the type examination certificate.

(2) The applicable body of standards, Minimum Performance Levels, notified body no. 0101 in accordance with Article 10 of the Directive 94/9/EC, and the Commission Decision and the Commission Decision on the application for the design and construction of equipment and protective systems intended for use in potentially explosive atmospheres, are specified in the certificate and the type examination certificate.

(3) The certificate holder and the manufacturer are bound to the technical conditions set out in the certificate and the type examination certificate.

(4) The certificate holder and the manufacturer are bound to the technical conditions set out in the certificate and the type examination certificate.

(5) The certificate holder and the manufacturer are bound to the technical conditions set out in the certificate and the type examination certificate.

(6) The certificate holder and the manufacturer are bound to the technical conditions set out in the certificate and the type examination certificate.

(7) The certificate holder and the manufacturer are bound to the technical conditions set out in the certificate and the type examination certificate.

(8) The certificate holder and the manufacturer are bound to the technical conditions set out in the certificate and the type examination certificate.

(9) The certificate holder and the manufacturer are bound to the technical conditions set out in the certificate and the type examination certificate.

(10) The certificate holder and the manufacturer are bound to the technical conditions set out in the certificate and the type examination certificate.

(11) The certificate holder and the manufacturer are bound to the technical conditions set out in the certificate and the type examination certificate.

(12) The certificate holder and the manufacturer are bound to the technical conditions set out in the certificate and the type examination certificate.

**II 2G EEx em [II] IC T5**  
**II 2D IP66 T 100 °C**  
**-25 °C ≤ Ta ≤ +60 °C**

**II 2G EEx em [II] IC T6**  
**II 2D IP66 T 30 °C**  
**-25 °C ≤ Ta ≤ +40 °C**

**Deutsche Messen Technologie GmbH**  
Lindt, Level 12, Finken 2001

Signature:   
 Date: **20.05.2019**

**TÜV**  
**ÖSTERREICH**

**A PÜZ**

TÜV Österreich, dem internationalen Bureauverband für technische Prüfingenieurwesen (Internationaler Verband für Technische Prüfingenieurwesen) (IVT) angeschlossen ist.

**(1) ERKLÄRUNG ÜBER DIE QUALITÄTSSICHERUNG PRODUKTION**

(2) Geräte und Schutzsysteme zur bestimmungsgemäßen Verwendung in explosionsgefährdeten Bereichen - Richtlinie 94/9/EG

(3) Erklärung Nr.: **TÜV-A 03 ATEX 0004 Q**

(4) Gerät: elektronische und optische Signalgeräte, Leuchten, Zündschaltern  
 EN 50017: „Erhöhte Sicherheit - e“  
 EN 50018: „Direktfassung - d“

(5) Antragsteller: 2-Axial Filter elektronischer Maschinen Gesellschaft mbH  
 A-1120 Wien, Seiberggasse 24

(6) Hersteller (Fertigungsort): 2-Axial Filter elektronischer Maschinen Gesellschaft mbH  
 A-1120 Wien, Seiberggasse 24

(7) TÜV Österreich, die Besondere Stelle Nr. 0408 gemäß Artikel 9 der Richtlinie des Rates der Europäischen Union vom 23. März 1994 (1994/9/EG) bescheinigt hiermit, dass die Qualitätssicherung des oben genannten Herstellers die Bedingungen der Richtlinie erfüllt.

(8) Diese Erklärung basiert auf dem Auditbericht Nr. 2019-ET-FZV-EX-104-BiStelle 0101.

(9) Diese Erklärung kann jederzeit widerrufen werden, wenn der Hersteller die Ergebnisse der periodischen Neuauflage des Qualitätsmanagementsystems nicht akzeptiert.

(10) Diese Erklärung gilt bis 31.12.2025 und kann jederzeit widerrufen werden, wenn der Hersteller die Überwachungsbedingungen des Qualitätsmanagementsystems nicht akzeptiert.

(11) Gemäß Artikel 10(1) der Richtlinie 94/9/EG soll der CE-Kennzeichen 0408 angefügt werden. Diese Identifizierung des Herstellers ist die Überwachung des Herstellers.

**CE**  
**0408**

31.12.2020  
 Datum der Ausstellung

**Zertifizierungsstelle**  
 Dr. phil. habil.   
 Regierungsdirektor

**TÜV NORD**  
**ATTESTATION OF CONFORMITY CERTIFICATE**

Manufacturer's Name and Address: **2-Axial Filter elektronischer Maschinen GmbH**  
 Seiberggasse 24, A-1120 Wien, Austria

Certificate ID: **212288807/021904**

This certificate belongs to the product of the product. This certificate is to confirm that the sample complies with the requirements set out below. The Commission of European Communities (CE) mark is placed at the request of the manufacturer in the product.

Standard: **EN 50018:2000**

Product Description: **2-Axial Filter elektronischer Maschinen GmbH**

Model & Type: **2-Axial Filter elektronischer Maschinen GmbH**

Inspection Date or Duration: **20.05.2019**

Certificate Expiry Date: **31.12.2025**

Report Number: **212288807/001**



















Production Place: **Seiberggasse 24, A-1120 Wien, Austria**

Registered Trademark: **2-Axial Filter elektronischer Maschinen GmbH**

Country: **Austria**

Intended for: **2-Axial Filter elektronischer Maschinen GmbH**

Signature:   
 Date: **20.05.2019**

	<b>TEPE FANLARI - FANLI FİLTRELER - PANO HAVALANDIRMA FİLTRELERİ - PANO İÇİ TERMOSTAT ve HYGROSTAT - PANO ISITICILARI - LED ARMATÜR - PANO KLİMALARI</b>		07-22
	<b>ENDÜSTRİYEL FANLAR</b>		23-32
	<b>ENDÜSTRİYEL FANLAR</b>		33-48
	<b>ENDÜSTRİYEL FANLAR</b>		49-51
	<b>OPTİK SİNYALLER</b>	 Auer Signal	52-63
	<b>İKAZ KULELERİ</b>	 Auer Signal	64-110
	<b>OPTİK AKUSTİK SİNYALLER</b>	 Auer Signal	111-119
	<b>AKUSTİK KORNALAR</b>	 Auer Signal	120-124
	<b>TELEFONLAR</b>	 Auer Signal	125-128
	<b>EX-PROOF SİNYAL EKİPMANLARI</b>	 Auer Signal	129-132
	<b>AKSESUARLAR</b>	 Auer Signal	133-135

İçindekiler



**ESEN**  
Elektrik San. ve Tic. Ltd. Şti

## 1988 yılından günümüze;

İlk olarak dünyanın önde gelen markalarının bayiliğini yaparak ticari faaliyetine başlayan Esen Elektrik; elektrik ve otomasyon sektöründe yapmış olduğu kalıcı yatırımlarla, yenilikçi ve vizyoner tavrıyla adım adım sektörün belirleyici isimlerinden olmuştur. Bünyesine kattığı, Auer marka (Avusturya) ikaz kuleleri, optik sinyaller, ex-proof sinyal ekipmanları vs. ürünler ve Fulltech marka (Taiwan) endüstriyel fan grubu ürünlerinin Türkiye distribütörlüğünü yapmaktadır. Aynı zamanda 2003 yılından itibaren de **QUICK** markası adı altında üretim hayatına devam etmektedir.

### **QUICK air conditioning**

Türkiye de ilk Esen Elektrik bünyesinde imalatına başlanılan bir çok alanda kullanılan iklimlendirme grubu **QUICK** marka ürünler kısa zamanda tartışılmaz kalitesiyle başarı sağlamıştır. Vermiş olduğu güvenle başarı hikayesinde sürekli olarak büyüme kaydetmiş, uygun fiyat, üstün kalite prensibiyle 2003 yılından itibaren Türkiye ve Dünyada tercih edilen bir marka haline gelmiştir.

(tepe fanları, fanlı filtre, filtre, pano ısıtıcısı, termostat, hygrostat, led armatür, proje cebi, pano kliması.)

Esen Elektrik var olan ürün portföyüne Uluslararası standartlara uygun sürekli gelişim amacı gözetilen yeni ürünler eklemeyi hedeflemektedir. Halen 1988 yılında kurucusu olan sayın Hüseyin Sarıgül tarafından yönetilmektedir.



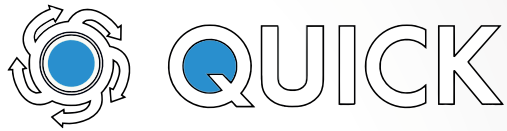

# SOLUTIONS FOR ENCLOSURE

## NC - NO THERMOSTAT

- Large Setting Range
- 110-250VAC, 10A
- (-10)-(+80)°C
- ABS UL-94 V0



## DOUBLE THERMOSTAT

- Large Setting Range
- 230V AC, 10A
- (-10)-(+80)°C
- ABS UL-94 V0



## HYGROSTAT

- Large Setting Range
- 110-250VAC, IP20
- ABS UL-94 V0



## AXIAL FAN

- Compact Design
- 12V DC, 24V DC, 48V DC
- 110V AC, 230V AC



## FILTER FANS

- 5 Sizes With/Without Fan
- Protection Class: IP54-IP55
- Easy Assembling



## AIR CONDITIONING for ELECTRICAL PANELS

- Cooling Capacity (W)  
350W, 500W, 750W, 1000W, 1500W, 1700W  
2000W, 2500W, 3000W, 3500W, 4000W
- Protection Class: IP54



## FULL SERIES ROOF FANS

- Protection Class: IP54-IP55
- 570m³/h, 970m³/h, 1250m³/h
- ABS UL94 V0



## QFF SERIES ROOF FANS

- Protection Class: IP44
- 400m³/h, 570m³/h, 970m³/h
- ABS UL94 V0



## LED LAMP For CABINET

- Banded Armature With Led
- Open - Close Button



## HEATERS

- Operating Voltage: 110-240V AC/DC
- Wide Range Operation Voltages
- Auto Temperature Limiting
- Working range : (-40)-(+70)°C







QUICK

TEPE FANLARI & FİLTRELER



## ÜST KAPAK RENK ÇEŞİTLERİ

				
Kırmızı	Mavi	Füme	Turuncu	Gri

## GÖVDE RENGİ

 RAL 7035 (Gri)

## TEKNİK RESİM

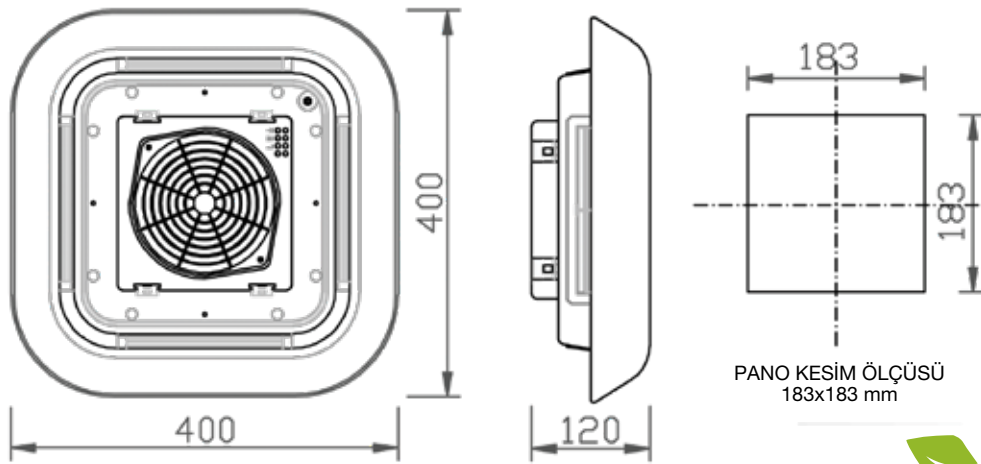

 **Halogen free**

MODEL	ÖLÇÜLER mm	BESLEME VAC	KAPASİTE M <sup>3</sup> /h	GÜÇ W	NOMİNAL Akım	GÜRÜLTÜ SEVİYESİ (db)	KORUMA SINIFI	Fiyat (€)
<b>FULL4000</b>	400x400x120	230VAC-50/60Hz	384	45	0.27	58	IP54	100
<b>FULL5500</b>	400x400x120	230VAC-50/60Hz	570	52 / 65	0.23 / 0.29	62	IP54	130
<b>FULL6000</b>	400x400x120	230VAC-50/60Hz	1050	102 / 135	0.45 / 0.60	65	IP54	140
<b>FULL1250</b>	400x400x120	230VAC-50/60Hz	1250	155 / 210	0.68 / 0.92	75	IP54	190

## Thermally-Protected



Poliüretan Conta



VO Alev İletmez ABS

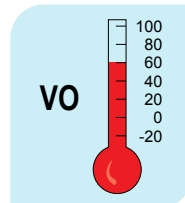

Hızlı ve Kolay Montaj



IP54





## TEKNİK RESİM

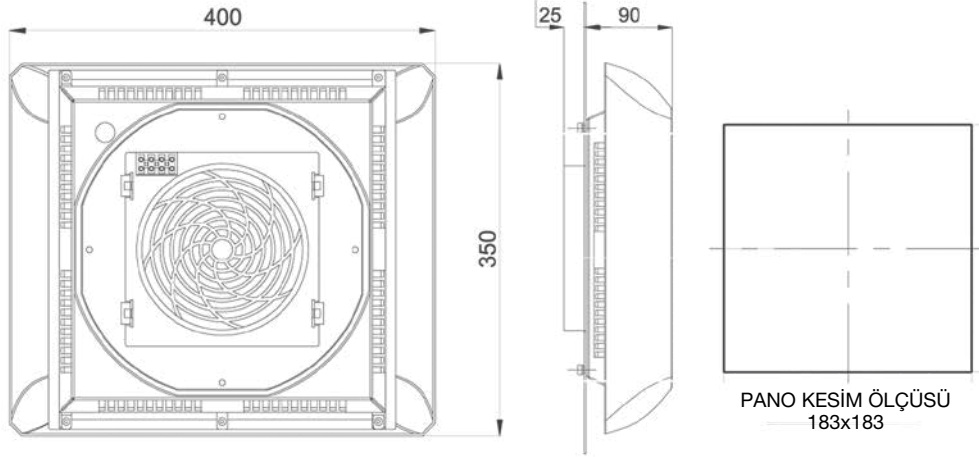

 **Halogen free**

MODEL	ÖLÇÜLER mm	BESLEME VAC	KAPASİTE m <sup>3</sup> /h	GÜÇ W	NOMİNAL Akım	GÜRÜLTÜ SEVİYESİ (db)	KORUMA SINIFI	Fiyat (€)
<b>QFF 4000</b>	400x350x102	230VAC-50/60Hz	384	45	0.27	58	IP44	<b>85</b>
<b>QFF 5500</b>	400x350x102	230VAC-50/60Hz	570	52 / 65	0.23 / 0.29	62	IP44	<b>110</b>
<b>QFF 6000</b>	400x350x102	230VAC-50/60Hz	1050	102 / 135	0.45 / 0.60	73	IP44	<b>125</b>

## Thermally-Protected



Poliüretan Conta



VO Alev İletmez ABS

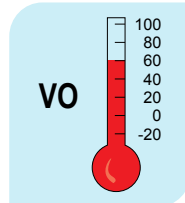

Hızlı ve Kolay Montaj



IP44





## TEKNİK RESİM

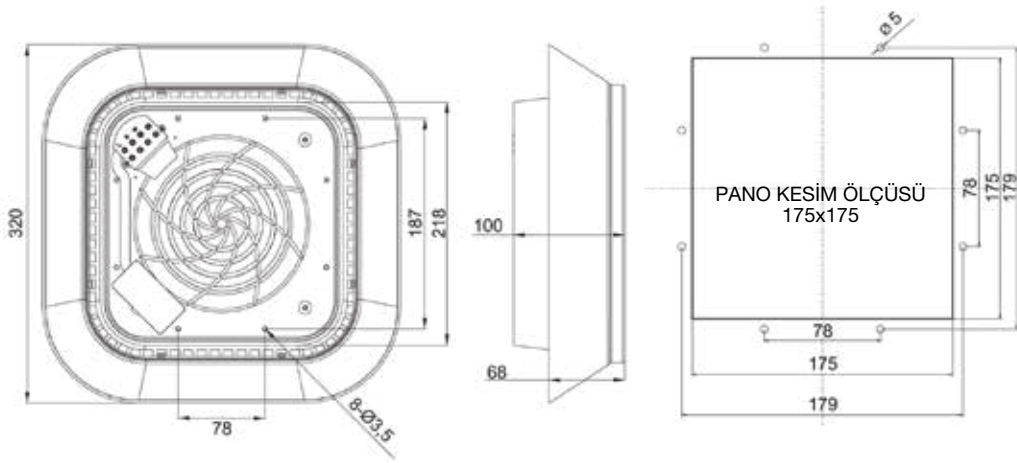

**Halogen free**

MODEL	ÖLÇÜLER mm	BESLEME VAC	KAPASİTE M <sup>3</sup> /h	GÜÇ W	NOMİNAL Akım	GÜRÜLTÜ SEVİYESİ (db)	KORUMA SINIFI	Fiyat (€)
<b>RF190APA23-H</b>	320x320x100	230VAC-50Hz	570	58	0.26	62	IP 44	150



## Thermally-Protected



Poliüretan Conta



VO Alev İletmez ABS

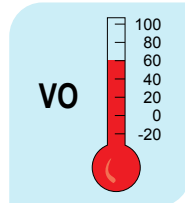

IP44



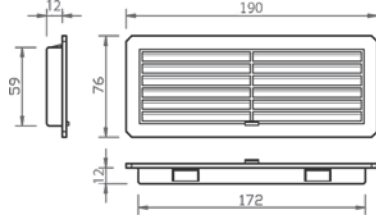
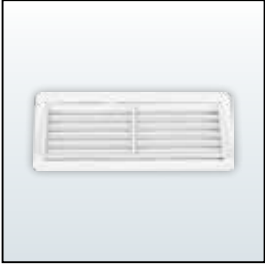

PANO KESİM ÖLÇÜSÜ  
61 x 175 mm

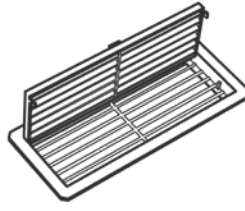

MODEL	<b>FİL 500</b>
ÖLÇÜ mm	190x76x12
Fiyat (€)	4

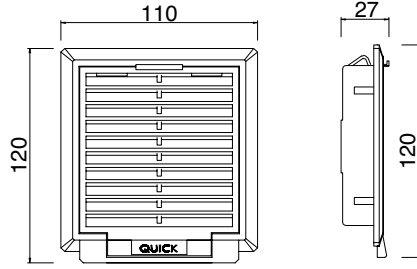

PANO KESİM ÖLÇÜSÜ  
92,5 x 92,5 mm

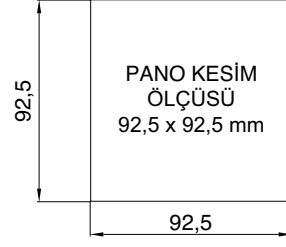

MODEL	<b>FİL 1000</b>
ÖLÇÜ mm	120X110X27
Fiyat (€)	4

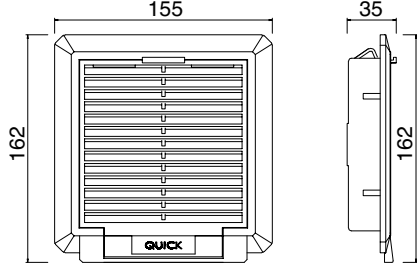

PANO KESİM ÖLÇÜSÜ  
125 x 125 mm

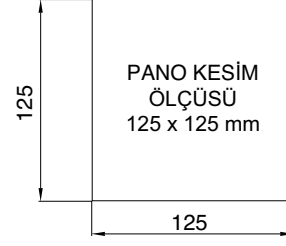

MODEL	<b>FİL 1500</b>
ÖLÇÜ mm	162X155X35
Fiyat (€)	5

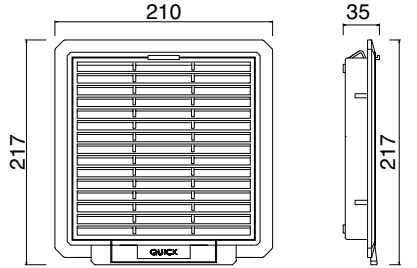

PANO KESİM ÖLÇÜSÜ  
177 x 177 mm

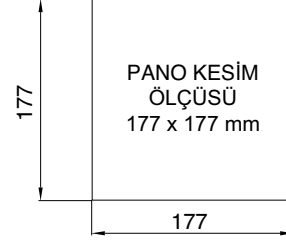

MODEL	<b>FİL 2000</b>
ÖLÇÜ mm	217X210X35
Fiyat (€)	10

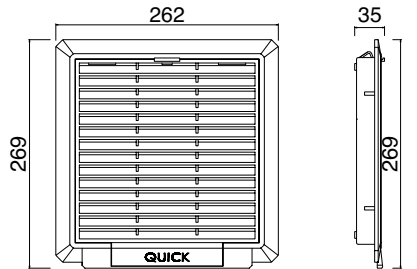

PANO KESİM ÖLÇÜSÜ  
223 x 223mm

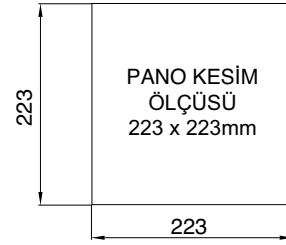

MODEL	<b>FİL 2500</b>
ÖLÇÜ mm	269X262X35
Fiyat (€)	12

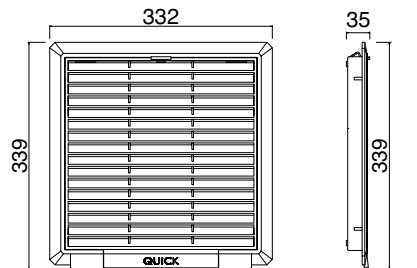

PANO KESİM ÖLÇÜSÜ  
291 x 291mm

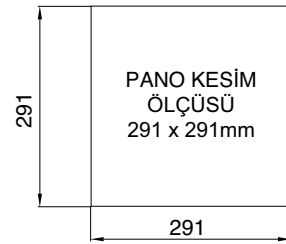

MODEL	<b>FİL 3000</b>
ÖLÇÜ mm	339X332X35
Fiyat (€)	20

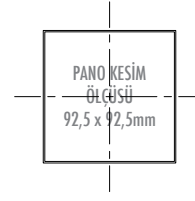
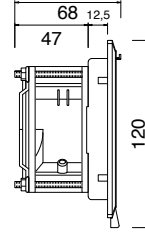
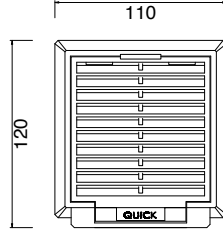

MODEL	AÇIKLAMA	ÖLÇÜLER mm	BESLEME VAC	GÜÇ W	HIZ dev/dak	FİLTRESİZ M³/h	FİLTRELİ M³/h	NOMİNAL Akım	GÜRÜLTÜ SEVİYESİ dB	Fiyat (€)
<b>FULL 1000</b>	Fanlı Filtre	120X110X68	230VAC-50/60Hz	15 / 13	2850	41	30	0.08	32	<b>30</b>

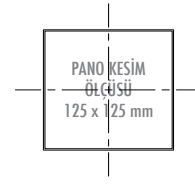
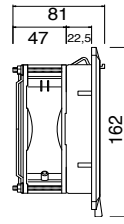
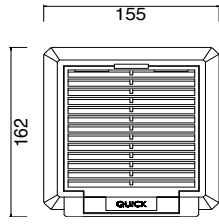

MODEL	AÇIKLAMA	ÖLÇÜLER mm	BESLEME VAC	GÜÇ W	HIZ dev/dak	FİLTRESİZ M³/h	FİLTRELİ M³/h	NOMİNAL Akım	GÜRÜLTÜ SEVİYESİ dB	Fiyat (€)
<b>FULL 1500</b>	Fanlı Filtre	162X155X81	230VAC-50/60Hz	17 / 15	2850	156	108	0.14	45	<b>32</b>

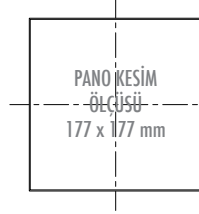
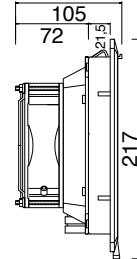
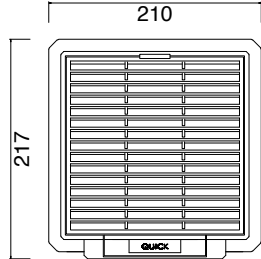

MODEL	AÇIKLAMA	ÖLÇÜLER mm	BESLEME VAC	GÜÇ W	HIZ dev/dak	FİLTRESİZ M³/h	FİLTRELİ M³/h	NOMİNAL Akım	GÜRÜLTÜ SEVİYESİ dB	Fiyat (€)
<b>FULL 2000</b>	Fanlı Filtre	217X210X105	230V-50Hz	17/15	2850	174	130	0.14	46	<b>40</b>

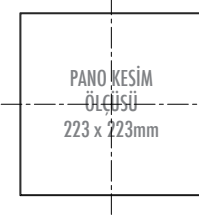
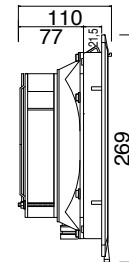
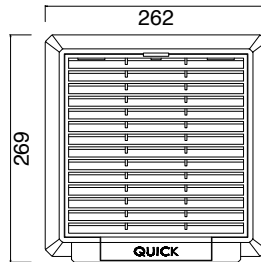

MODEL	AÇIKLAMA	ÖLÇÜLER mm	BESLEME VAC	GÜÇ W	HIZ dev/dak	FİLTRESİZ M³/h	FİLTRELİ M³/h	NOMİNAL Akım	GÜRÜLTÜ SEVİYESİ dB	Fiyat (€)
<b>FULL 2500</b>	Fanlı Filtre	269X262X110	230VAC-50/60Hz	27 / 26	2850	300	225	0.17 / 0.16	45	<b>50</b>

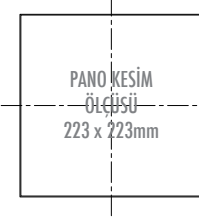
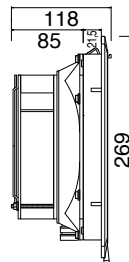
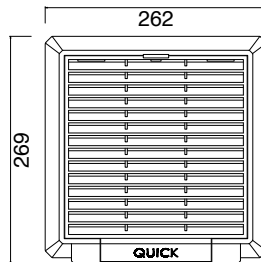

MODEL	AÇIKLAMA	ÖLÇÜLER mm	BESLEME VAC	GÜÇ W	HIZ dev/dak	FİLTRESİZ M³/h	FİLTRELİ M³/h	NOMİNAL Akım	GÜRÜLTÜ SEVİYESİ dB	Fiyat (€)
<b>FULL 3000</b>	Fanlı Filtre	269X262X118	230VAC-50/60Hz	38 / 36	2850	348	261	0.23	45	<b>55</b>

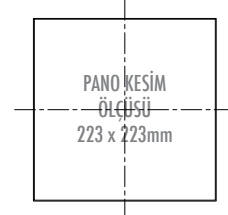
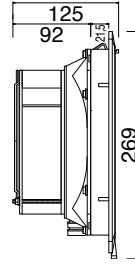
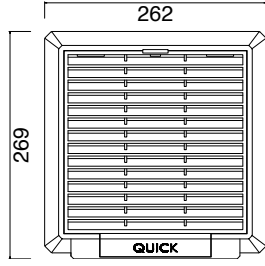

MODEL	AÇIKLAMA	ÖLÇÜLER mm	BESLEME VAC	GÜÇ W	HIZ dev/dak	FİLTRESİZ M³/h	FİLTRELİ M³/h	NOMİNAL Akım	GÜRÜLTÜ SEVİYESİ dB	Fiyat (€)
<b>FULL 3500</b>	Fanlı Filtre	269X262X125	230V-50Hz	38 / 36	2850	384	288	0.23	45	<b>90</b>

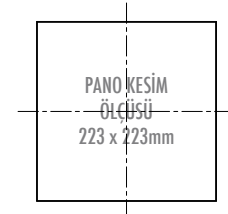
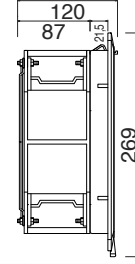
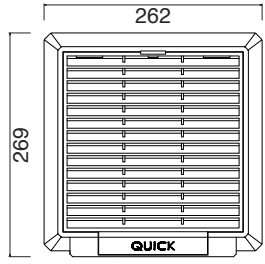

MODEL	AÇIKLAMA	ÖLÇÜLER mm	BESLEME VAC	GÜÇ W	HIZ dev/dak	FİLTRESİZ M³/h	FİLTRELİ M³/h	NOMİNAL Akım	GÜRÜLTÜ SEVİYESİ dB	Fiyat (€)
<b>FULL 4500</b>	Fanlı Filtre	269X262X120	230V-50Hz	80 / 80	2850	975	775	0.40	61	<b>140</b>

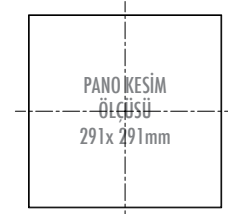
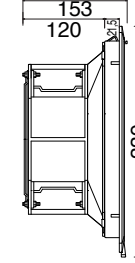
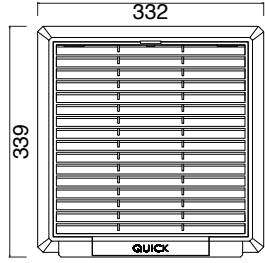

MODEL	AÇIKLAMA	ÖLÇÜLER mm	BESLEME VAC	GÜÇ W	HIZ dev/dak	FİLTRESİZ M³/h	FİLTRELİ M³/h	NOMİNAL Akım	GÜRÜLTÜ SEVİYESİ dB	Fiyat (€)
<b>FULL 5000</b>	Fanlı Filtre	339X332X153	230V-50Hz	80 / 80	2850	975	850	0.40	61	<b>160</b>

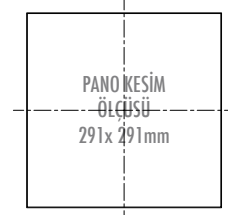
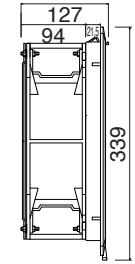
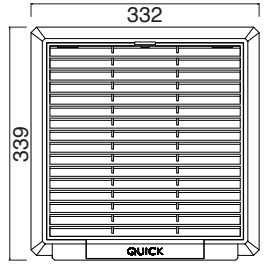

MODEL	AÇIKLAMA	ÖLÇÜLER mm	BESLEME VAC	GÜÇ W	HIZ dev/dak	FİLTRESİZ M³/h	FİLTRELİ M³/h	NOMİNAL Akım	GÜRÜLTÜ SEVİYESİ dB	Fiyat (€)
<b>FULL 6500</b>	Fanlı Filtre	339X332X127	230V-50Hz	127 / 180	2850	1850	1450	0.56 / 0.79	68	<b>180</b>

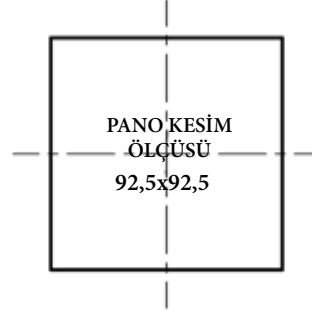
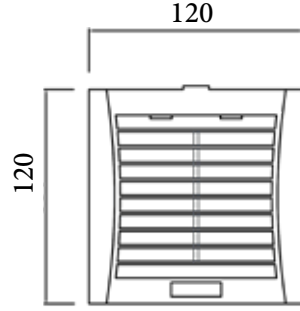

MODEL	<b>FİLL 1000 YNS IP54-55</b>
ÖLÇÜ mm	120x120x33
Fiyat (€)	4

PANO KESİM  
ÖLÇÜSÜ  
92,5x92,5

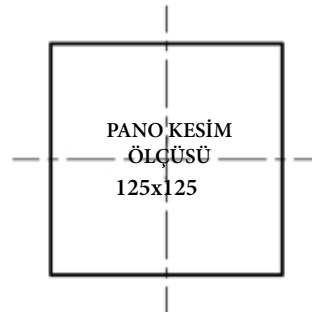
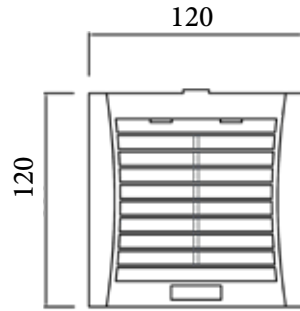

MODEL	<b>FİLL 1500 YNS IP54-55</b>
ÖLÇÜ mm	120x120x33
Fiyat (€)	5

PANO KESİM  
ÖLÇÜSÜ  
125x125

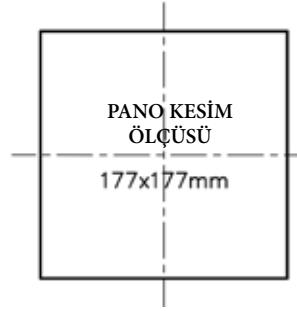
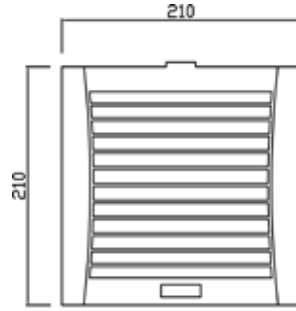

MODEL	<b>FİLL 2000 YNS IP54-55</b>
ÖLÇÜ mm	210x210x37
Fiyat (€)	10

PANO KESİM  
ÖLÇÜSÜ  
177x177mm

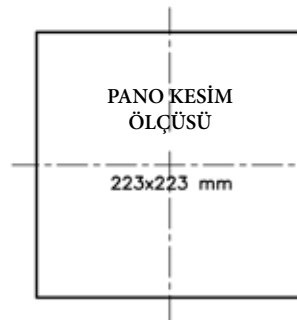
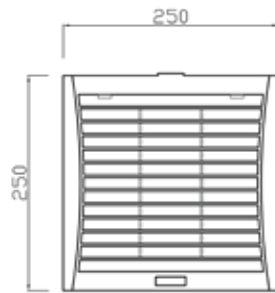

MODEL	<b>FİLL 2500 YNS IP54-55</b>
ÖLÇÜ mm	250x250x40
Fiyat (€)	12

PANO KESİM  
ÖLÇÜSÜ  
223x223 mm

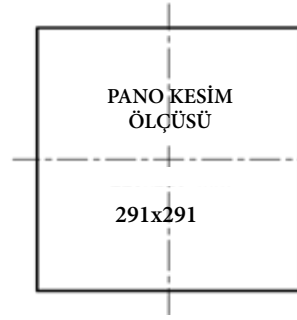
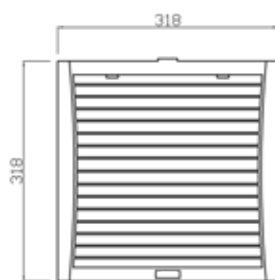

MODEL	<b>FİLL 3000 YNS IP54-55</b>
ÖLÇÜ mm	318x318x43
Fiyat (€)	20

PANO KESİM  
ÖLÇÜSÜ  
291x291



120

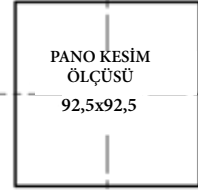
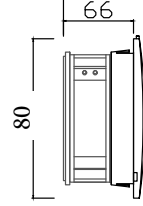
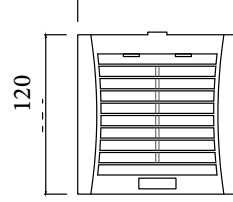

PANO KESİM  
ÖLÇÜSÜ  
92,5x92,5

MODEL	AÇIKLAMA	ÖLÇÜLER mm	BESLEME DC	GÜÇ W	HIZ dev/dak	FİLTRESİZ M³/h	FİLTRELİ M³/h	NOMİNAL Akım	GÜRÜLTÜ SEVİYESİ dB	Fiyat (€)
<b>FULL 1000 YNS IP54-55</b>	Fanlı Filtre	120x120x77	24VDC	4	3000	62	50	0.15	32	<b>30</b>

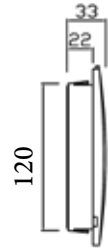
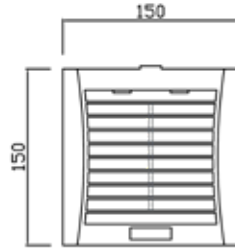

PANO KESİM  
ÖLÇÜSÜ  
125x125

MODEL	AÇIKLAMA	ÖLÇÜLER mm	BESLEME DC	GÜÇ W	HIZ dev/dak	FİLTRESİZ M³/h	FİLTRELİ M³/h	NOMİNAL Akım	GÜRÜLTÜ SEVİYESİ dB	Fiyat (€)
<b>FULL 1500 YNS IP54-55</b>	Fanlı Filtre	150x150x77	24VDC	4,80	3000	165	130	0,4	38	<b>35</b>

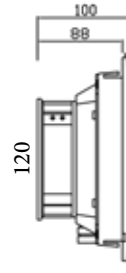
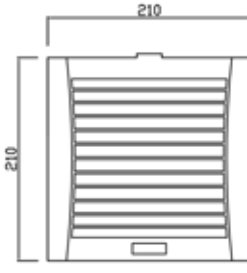

PANO KESİM  
ÖLÇÜSÜ  
177x177mm

MODEL	AÇIKLAMA	ÖLÇÜLER mm	BESLEME DC	GÜÇ W	HIZ dev/dak	FİLTRESİZ M³/h	FİLTRELİ M³/h	NOMİNAL Akım	GÜRÜLTÜ SEVİYESİ dB	Fiyat (€)
<b>FULL 2000 YNS IP54-55</b>	Fanlı Filtre	210x210x100	24VDC	4,80	3000	165	130	0,4	38	<b>40</b>

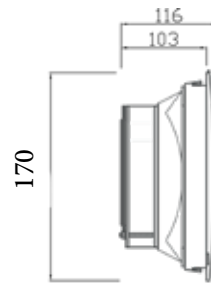
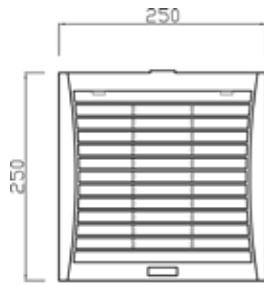

PANO KESİM  
ÖLÇÜSÜ  
223x223 mm

MODEL	AÇIKLAMA	ÖLÇÜLER mm	BESLEME DC	GÜÇ W	HIZ dev/dak	FİLTRESİZ M³/h	FİLTRELİ M³/h	NOMİNAL Akım	GÜRÜLTÜ SEVİYESİ dB	Fiyat (€)
<b>FULL 2500 YNS IP54-55</b>	Fanlı Filtre	250x250x116	24VDC	12	2500	277	210	0,5	48	<b>55</b>

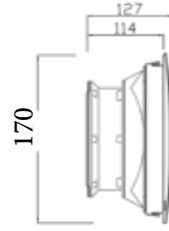
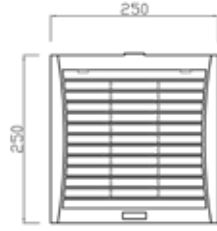
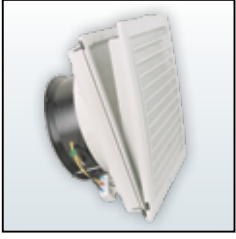

MODEL	AÇIKLAMA	ÖLÇÜLER mm	BESLEME DC	GÜÇ W	HIZ dev/dak	FİLTRESİZ M³/h	FİLTRELİ M³/h	NOMİNAL Akım	GÜRÜLTÜ SEVİYESİ dB	Fiyat (€)
<b>FULL 3000 YNS IP54-55</b>	Fanlı Filtre	250X250X127	24VDC	12	3000	350	162	0,5	50,55	<b>70</b>

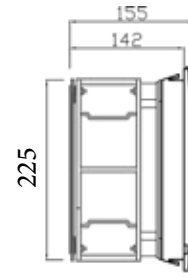
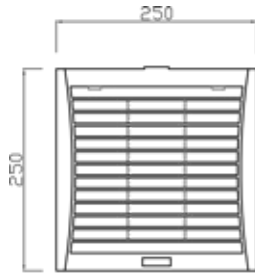

MODEL	AÇIKLAMA	ÖLÇÜLER mm	BESLEME DC	GÜÇ W	HIZ dev/dak	FİLTRESİZ M³/h	FİLTRELİ M³/h	NOMİNAL Akım	GÜRÜLTÜ SEVİYESİ dB	Fiyat (€)
<b>FULL 4500 YNS IP54-55</b>	Fanlı Filtre	250X250X155	24VDC	28,8	2700	800	600	1,2	60	<b>150</b>

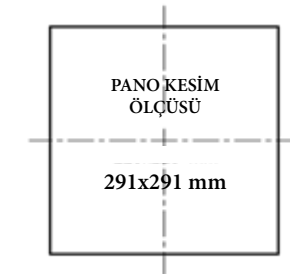
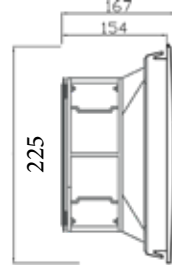
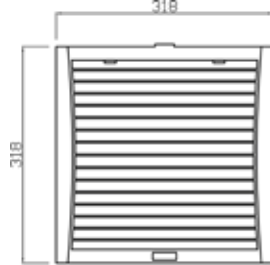

MODEL	AÇIKLAMA	ÖLÇÜLER mm	BESLEME DC	GÜÇ W	HIZ dev/dak	FİLTRESİZ M³/h	FİLTRELİ M³/h	NOMİNAL Akım	GÜRÜLTÜ SEVİYESİ dB	Fiyat (€)
<b>FULL 5000 YNS IP54-55</b>	Fanlı Filtre	318X318X167	24VDC	28,8	2700	800	600	1,2	60	<b>160</b>

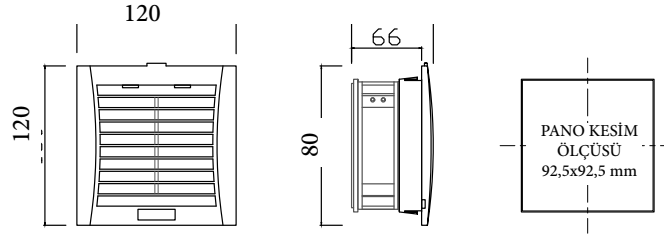

MODEL	AÇIKLAMA	ÖLÇÜLER mm	BESLEME VAC	GÜÇ W	HIZ dev/dak	FİLTRESİZ M³/h	FİLTRELİ M³/h	NOMİNAL Akım	GÜRÜLTÜ SEVİYESİ dB	Fiyat (€)
<b>FULL 1000 YNS IP54-55</b>	Fanlı Filtre	120X120X77	230VAC-50/60Hz	15 / 13	2850	41	30	0.08	32	<b>30</b>

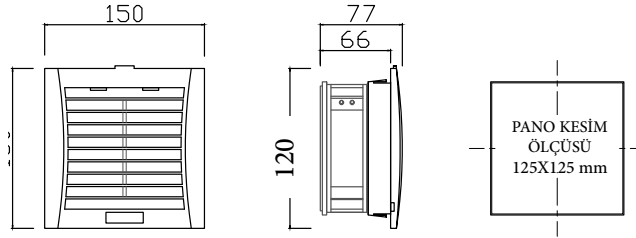

MODEL	AÇIKLAMA	ÖLÇÜLER mm	BESLEME VAC	GÜÇ W	HIZ dev/dak	FİLTRESİZ M³/h	FİLTRELİ M³/h	NOMİNAL Akım	GÜRÜLTÜ SEVİYESİ dB	Fiyat (€)
<b>FULL 1500 YNS IP54-55</b>	Fanlı Filtre	150X150X77	230VAC-50/60Hz	17 / 15	2850	156	108	0.14	45	<b>32</b>

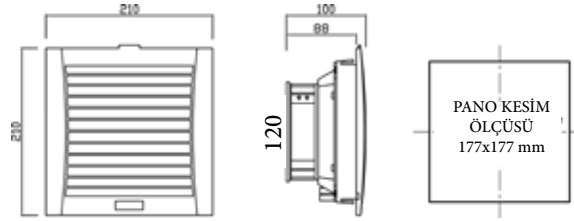

MODEL	AÇIKLAMA	ÖLÇÜLER mm	BESLEME VAC	GÜÇ W	HIZ dev/dak	FİLTRESİZ M³/h	FİLTRELİ M³/h	NOMİNAL Akım	GÜRÜLTÜ SEVİYESİ dB	Fiyat (€)
<b>FULL 2000 YNS IP54-55</b>	Fanlı Filtre	210X210X100	230V-50Hz	17/15	2850	174	130	0.14	46	<b>40</b>

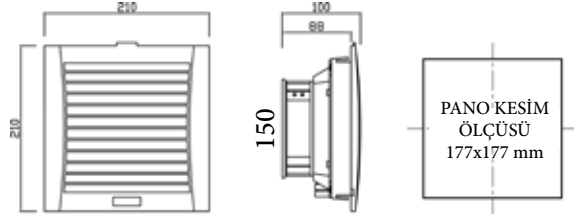

MODEL	AÇIKLAMA	ÖLÇÜLER mm	BESLEME VAC	GÜÇ W	HIZ dev/dak	FİLTRESİZ M³/h	FİLTRELİ M³/h	NOMİNAL Akım	GÜRÜLTÜ SEVİYESİ dB	Fiyat (€)
<b>FULL 2300 YNS IP54-55</b>	Fanlı Filtre	210X210X116	230VAC-50/60Hz	27 / 26	2850	300	225	0.17 / 0.16	45	<b>45</b>

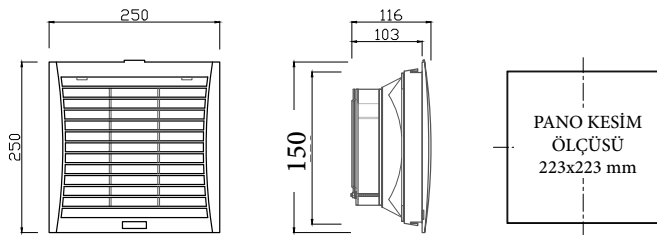

MODEL	AÇIKLAMA	ÖLÇÜLER mm	BESLEME VAC	GÜÇ W	HIZ dev/dak	FİLTRESİZ M³/h	FİLTRELİ M³/h	NOMİNAL Akım	GÜRÜLTÜ SEVİYESİ dB	Fiyat (€)
<b>FULL 2500 YNS IP54-55</b>	Fanlı Filtre	250X250X116	230VAC-50/60Hz	27 / 26	2850	300	225	0.17 / 0.16	45	<b>50</b>

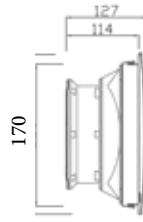
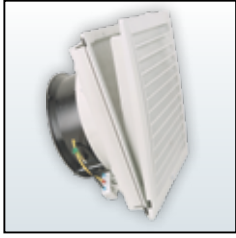

MODEL	AÇIKLAMA	ÖLÇÜLER mm	BESLEME VAC	GÜÇ W	HIZ dev/dak	FİLTRESİZ M³/h	FİLTRELİ M³/h	NOMİNAL Akım	GÜRÜLTÜ SEVİYESİ dB	Fiyat (€)
<b>FULL 3000 YNS IP54-55</b>	Fanlı Filtre	250X250X127	230VAC-50/60Hz	38 / 36	2850	348	261	0.23	45	<b>55</b>

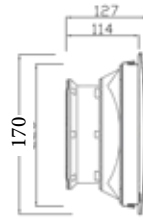

MODEL	AÇIKLAMA	ÖLÇÜLER mm	BESLEME VAC	GÜÇ W	HIZ dev/dak	FİLTRESİZ M³/h	FİLTRELİ M³/h	NOMİNAL Akım	GÜRÜLTÜ SEVİYESİ dB	Fiyat (€)
<b>FULL 3500 YNS IP54-55</b>	Fanlı Filtre	269X262X125	230V-50Hz	38 / 36	2850	384	288	0.23	45	<b>90</b>

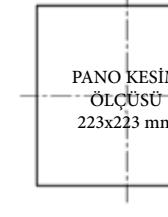
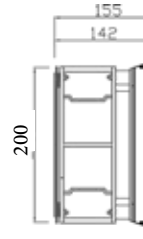
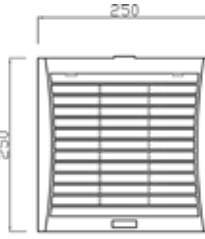

MODEL	AÇIKLAMA	ÖLÇÜLER mm	BESLEME VAC	GÜÇ W	HIZ dev/dak	FİLTRESİZ M³/h	FİLTRELİ M³/h	NOMİNAL Akım	GÜRÜLTÜ SEVİYESİ dB	Fiyat (€)
<b>FULL 4500 YNS IP54-55</b>	Fanlı Filtre	269X262X120	230V-50Hz	80 / 80	2850	975	775	0.40	61	<b>140</b>

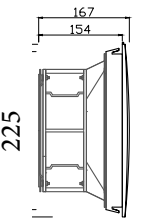
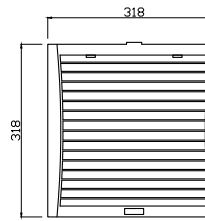

MODEL	AÇIKLAMA	ÖLÇÜLER mm	BESLEME VAC	GÜÇ W	HIZ dev/dak	FİLTRESİZ M³/h	FİLTRELİ M³/h	NOMİNAL Akım	GÜRÜLTÜ SEVİYESİ dB	Fiyat (€)
<b>FULL 5000 YNS IP54-55</b>	Fanlı Filtre	339X332X153	230V-50Hz	80 / 80	2850	975	850	0.40	61	<b>160</b>

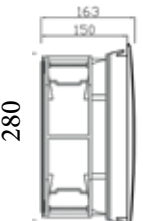
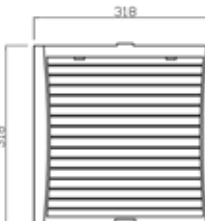

MODEL	AÇIKLAMA	ÖLÇÜLER mm	BESLEME VAC	GÜÇ W	HIZ dev/dak	FİLTRESİZ M³/h	FİLTRELİ M³/h	NOMİNAL Akım	GÜRÜLTÜ SEVİYESİ dB	Fiyat (€)
<b>FULL 6500 YNS IP54-55</b>	Fanlı Filtre	339X332X127	230V-50Hz	127 / 180	2850	1850	1450	0.56 / 0.79	68	<b>180</b>



TEKNİK RESİM

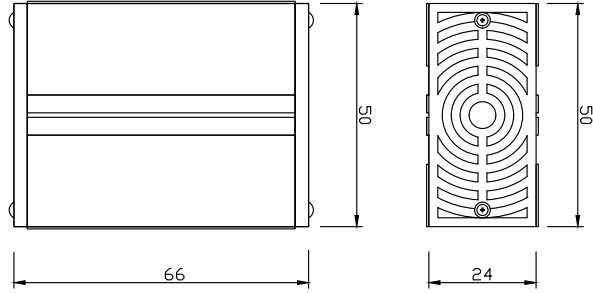

## MINİ PANO ISITICILARI

MODEL	VOLTAJ (V)	FREKANS (Hz)	GÜÇ (W)	GÖVDE SICAKLIĞI	IP	BOY (mm)	ISITICI GÖVDE	ISITICI ELEMAN	MONTAJ ŞEKLİ	BAĞLANTI	Fiyat (€)
QMHT-20W	110/240V AC/DC	50 60	20 20	74°C	20	60	Alüminyum	PTC	DIN35 RAY	Klemens	25
QMHT-40W	110/240V AC/DC	50 60	40 40	105°C	20	60	Alüminyum	PTC	DIN35 RAY	Klemens	30

TEKNİK RESİM

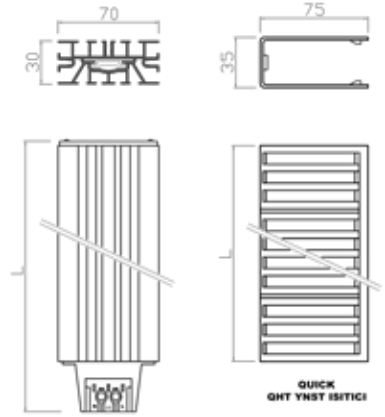

## TOPRAKLI PANO ISITICILARI

MODEL	VOLTAJ (V)	FREKANS (Hz)	GÜÇ (W)	GÖVDE SICAKLIĞI	IP	BOY (mm)	ISITICI GÖVDE	ISITICI ELEMAN	MONTAJ ŞEKLİ	BAĞLANTI	Fiyat (€)
QHT YNST-20W	110/240V AC/DC	50 60	20 20	85°C	20	95	Alüminyum	PTC	DIN35 RAY	Klemens	25
QHT YNST-30W	110/240V AC/DC	50 60	30 30	85°C	20	95	Alüminyum	PTC	DIN35 RAY	Klemens	27
QHT YNST-50W	110/240V AC/DC	50 60	50 50	85°C	20	95	Alüminyum	PTC	DIN35 RAY	Klemens	30
QHT YNST-75W	110/240V AC/DC	50 60	75 75	125°C	20	155	Alüminyum	PTC	DIN35 RAY	Klemens	31
QHT YNST-100W	110/240V AC/DC	50 60	100 100	125°C	20	155	Alüminyum	PTC	DIN35 RAY	Klemens	32
QHT YNST-125W	110/240V AC/DC	50 60	125 125	125°C	20	215	Alüminyum	PTC	DIN35 RAY	Klemens	40
QHT YNST-150W	110/240V AC/DC	50 60	150 150	130°C	20	215	Alüminyum	PTC	DIN35 RAY	Klemens	50
QHT YNST-200W	110/240V AC/DC	50 60	200 200	135°C	20	215	Alüminyum	PTC	DIN35 RAY	Klemens	55

TEKNİK RESİM

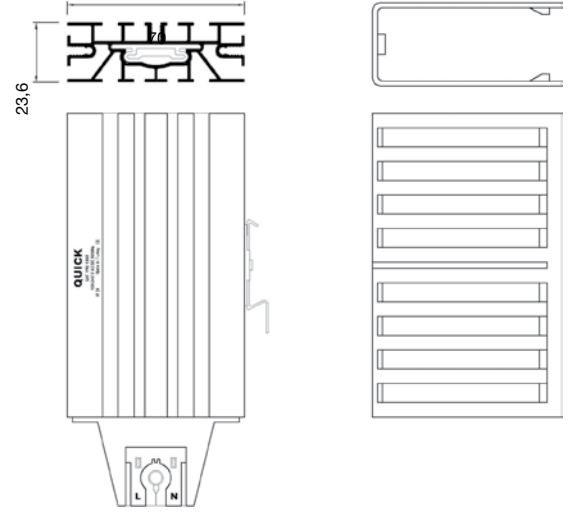

FANSIZ PANO ISITICILARI



MODEL	VOLTAJ (V)	FREKANS (Hz)	GÜÇ (W)	GÖVDE SICAKLIĞI	IP	BOY (mm)	ISITICI GÖVDE	ISITICI ELEMAN	MONTAJ ŞEKLİ	BAĞLANTI	Fiyat (€)
<b>QHT YNS-20W</b>	110/240V AC/DC	50 60	20 20	85°C	20	95	Alüminyum	PTC	DIN35 RAY	Klemens	<b>22</b>
<b>QHT YNS-30W</b>	110/240V AC/DC	50 60	30 30	85°C	20	95	Alüminyum	PTC	DIN35 RAY	Klemens	<b>24</b>
<b>QHT YNS-50W</b>	110/240V AC/DC	50 60	50 50	85°C	20	95	Alüminyum	PTC	DIN35 RAY	Klemens	<b>27</b>
<b>QHT YNS-75W</b>	110/240V AC/DC	50 60	75 75	125°C	20	155	Alüminyum	PTC	DIN35 RAY	Klemens	<b>29</b>
<b>QHT YNS-100W</b>	110/240V AC/DC	50 60	100 100	125°C	20	155	Alüminyum	PTC	DIN35 RAY	Klemens	<b>31</b>
<b>QHT YNS-125W</b>	110/240V AC/DC	50 60	125 125	125°C	20	215	Alüminyum	PTC	DIN35 RAY	Klemens	<b>39</b>
<b>QHT YNS-150W</b>	110/240V AC/DC	50 60	150 150	130°C	20	215	Alüminyum	PTC	DIN35 RAY	Klemens	<b>47</b>
<b>QHT YNS-200W</b>	110/240V AC/DC	50 60	200 200	135°C	20	215	Alüminyum	PTC	DIN35 RAY	Klemens	<b>52</b>



FANLI PANO ISITICILARI



MODEL	VOLTAJ (V)	FREKANS (Hz)	GÜÇ (W)	GÖVDE SICAKLIĞI	ÇALIŞMA SICAKLIĞI	IP	BOY (mm)	ISITICI GÖVDE	ISITICI ELEMAN	MONTAJ ŞEKLİ	BAĞLANTI	Fiyat (€)
<b>Cirrus 60</b>	230V AC	50 60	200 - 300 400	50°C	-10°C +70°C	20	71x70x98,2	Plastik	PTC	DIN35 RAY	Kablo	<b>120</b>
<b>Cirrus 80</b>	230V AC	50 60	450-800	80°C	-40°C +60°C	20	82x110x150	Alüminyum	PTC	DIN35 RAY	Klemens	<b>160</b>
<b>QFHT-250W</b>	230V AC	50 60	250	50°C	-40°C +70°C	20	190x60x80	Alüminyum	PTC	DIN35 RAY	Klemens	<b>100</b>



QHT NO Termostat

QHT NC Termostat

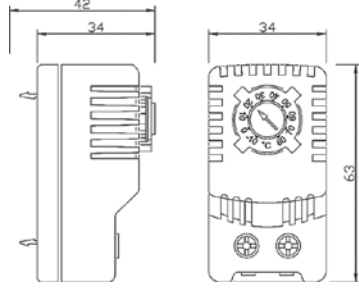

TEKNİK RESİM



QHT NCNO : Double Termostat

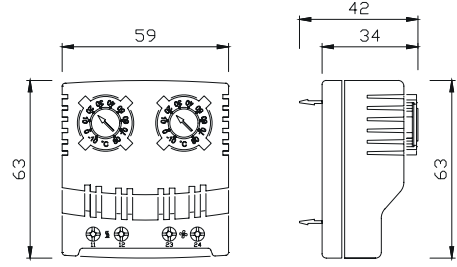

Pano termostatları , pano sıcaklığını ayarlanan çalışma sıcaklığında tutabilmek için kullanılan ısıtıcıları, fanları yada pano klimalarını kontrol etmek için kullanılırlar.

**QHT NC :** Pano ısıtıcılarının kontrolü için kullanılır. (NC Normalde kapalı kontaklı)

**QHT NO :** Filtreli fan ve Pano klimaları kontrolü için kullanılır. (NO Normalde açık kontaklı)

**QHT NCNO :** Double Termostat.

- Geniş sıcaklık ayar aralığı.
- Kompakt dizayn.
- 35 mm DIN raya kolay montaj.
- Yüksek anahtarlama akımı (10 A).
- Klemensli güvenilir bağlantı.
- Üstün teknoloji Bimetalik yapı.
- Yer kazandıran kolay montaj

QHT NC : Pano ısıtıcılarının kontrolü uygulaması

QHT NO : Filtreli fan ve Pano klimaları kontrolü uygulaması

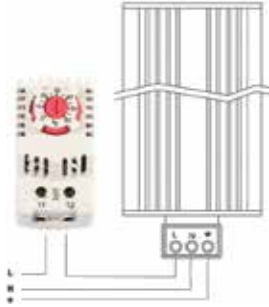

TEKNİK RESİM

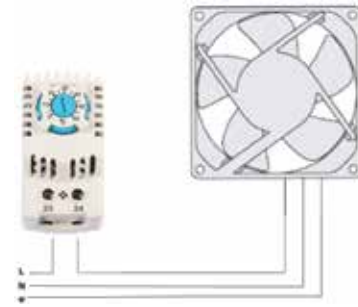

MODEL	VOLTAJ (V)	FREKANS (Hz)	SENSÖR ELEMANI	AYAR SAHASI	KONTAK TİPİ	AKIMI	KORUMA SINIFI	BOY (mm)	MONTAJ ŞEKLİ	BAĞLANTI (mm <sup>2</sup> )	Fiyat (€)
QHT-NC	110-250VAC	50 / 60	Bimetalik termostat.	(-10)-(+80)°C	NO	10A	IP20	63x34	DIN35 RAY	0,75 - 1,5	7
QHT-NO	110-250VAC	50 / 60	Bimetalik termostat.	(-10)-(+80)°C	NC	10A	IP20	63x34	DIN35 RAY	0,75 - 1,5	7
QHT-NC/NO	110-250VAC	50 / 60	Bimetalik termostat.	(-10)-(+80)°C	NC+NO	10A	IP20	63x59	DIN35 RAY	0,75 - 1,5	15

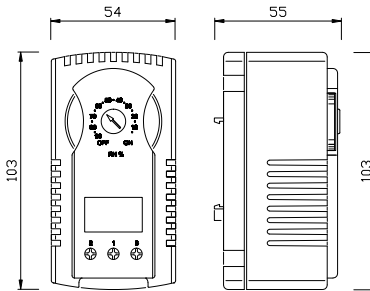

TEKNİK RESİM



HYGROSTAT

MODEL	VOLTAJ (V)	FREKANS (Hz)	KONTAKLAR	IP	ÖLÇÜ	AYAR ARALIĞI (%RH)	MONTAJ ŞEKLİ	BAĞLANTI	Fiyat (€)
QHG 500	110 / 250VAC	50 / 60	NO/NC	20	103x54x55	10-90	DIN35 RAY	2,5mm <sup>2</sup>	35





**QPC-A-4**



**QPC-A-5**

**PROJE CEPLERİ**

MODEL	AÇIKLAMA	ÖLÇÜ (mm)	FIYAT (€)
<b>QPC-A-4</b>	A-4 Proje Cebi	258x230x30	3,00
<b>QPC-A-5</b>	A-5 Proje Cebi	202x212x21	2,50



**QPA 270**



**QPA 540**



**QPA 810**



**QPA 1620**

**LEDLİ PANO İÇİ BANT ARMATÜR (AÇ - KAPA DÜĞMELİ)**

KOD	UZUNLUK	GÜÇ	LÜMEN	RENK	BAĞLANTI	FIYAT (MIKNATISLI)	FIYAT (MIKNATISSIZ)
<b>QPA 270</b>	20 cm	3 W	270 lm	beyaz	Klemens	12,00 €	10,00 €
<b>QPA 540</b>	30 cm	6 W	540 lm	beyaz	Klemens	17,00 €	15,00 €
<b>QPA 810</b>	40 cm	9 W	810 lm	beyaz	Klemens	22,00 €	20,00 €
<b>QPA 1620</b>	60 cm	18 W	1620 lm	beyaz	Klemens	27,00 €	25,00 €

## OUTDOOR (DIŞ ORTAM) PANO KLİMALARI

### INDOOR (İÇ ORTAM) RAL7035 PANO KLİMALARI



### INDOOR INOX (PASLANMAZ) PANO KLİMALARI



### INDOOR (İÇ ORTAM) RAL7035 PANO KLİMALARI (IP54)

AÇIKLAMA	KOD	BESLEME	SOĞUTMA GÜCÜ	AĞIRLIK (KG)	ÖLÇÜLER (YxGxD) mm	RENK	FİYAT
INDOOR PANO KLİMASI	QBT 350-01	220-230V 50/60Hz	340 W	22,5 Kg	550x300x230 mm	RAL 7035	1.265 €
INDOOR PANO KLİMASI	QBT 500-01	220-230V 50/60Hz	510 W	23,0 Kg	550x300x230 mm	RAL 7035	1.380 €
INDOOR PANO KLİMASI	QBT 750-01	220-230V 50/60Hz	720 W	25,0 Kg	640x315x230 mm	RAL 7035	1.553 €
INDOOR PANO KLİMASI	QBT 1000-01	220-230V 50/60Hz	1100 W	36,0 Kg	905x406x220 mm	RAL 7035	1.783 €
INDOOR PANO KLİMASI	QBT 1500-01	220-230V 50/60Hz	1580 W	37,0 Kg	905x406x220 mm	RAL 7035	1.955 €
INDOOR PANO KLİMASI	QBT 1700-01	220-230V 50/60Hz	1720 W	37,0 Kg	905x406x220 mm	RAL 7035	2.185 €
INDOOR PANO KLİMASI	QBT 2000-01	220-230V 50/60Hz	1950 W	45,0 Kg	1058x406x250 mm	RAL 7035	2.530 €
INDOOR PANO KLİMASI	QBT 2500-01	220-230V 50/60Hz	2570 W	50,5 Kg	1058x406x250 mm	RAL 7035	2.990 €
INDOOR PANO KLİMASI	QBT 3000-01	220-230V 50/60Hz	2920 W	53,0 Kg	1058x406x250 mm	RAL 7035	3.450 €
INDOOR PANO KLİMASI	QBT 3500-01	220-230V 50/60Hz	3380 W	64,0 Kg	1205x456x290 mm	RAL 7035	4.025 €
INDOOR PANO KLİMASI	QBT 4000-01	220-230V 50/60Hz	4050 W	64,0 Kg	1205x456x290 mm	RAL 7035	4.370 €

### INDOOR INOX (PASLANMAZ) PANO KLİMALARI (IP54)

AÇIKLAMA	KOD	BESLEME	SOĞUTMA GÜCÜ	AĞIRLIK (KG)	ÖLÇÜLER (YxGxD) mm	RENK	FİYAT
INOX PANO KLİMASI	QBT 350-02	220-230V 50/60Hz	340 W	22,5 Kg	550x300x230 mm	INOX	1.495 €
INOX PANO KLİMASI	QBT 500-02	220-230V 50/60Hz	510 W	23,0 Kg	550x300x230 mm	INOX	1.610 €
INOX PANO KLİMASI	QBT 750-02	220-230V 50/60Hz	720 W	25,0 Kg	640x315x230 mm	INOX	1.783 €
INOX PANO KLİMASI	QBT 1000-02	220-230V 50/60Hz	1100 W	36,0 Kg	905x406x220 mm	INOX	2.013 €
INOX PANO KLİMASI	QBT 1500-02	220-230V 50/60Hz	1580 W	37,0 Kg	905x406x220 mm	INOX	2.185 €
INOX PANO KLİMASI	QBT 1700-02	220-230V 50/60Hz	1720 W	37,0 Kg	905x406x220 mm	INOX	2.415 €
INOX PANO KLİMASI	QBT 2000-02	220-230V 50/60Hz	1950 W	45,0 Kg	1058x406x250 mm	INOX	2.760 €
INOX PANO KLİMASI	QBT 2500-02	220-230V 50/60Hz	2570 W	50,5 Kg	1058x406x250 mm	INOX	3.220 €
INOX PANO KLİMASI	QBT 3000-02	220-230V 50/60Hz	2920 W	53,0 Kg	1058x406x250 mm	INOX	3.680 €
INOX PANO KLİMASI	QBT 3500-02	220-230V 50/60Hz	3380 W	64,0 Kg	1205x456x290 mm	INOX	4.255 €
INOX PANO KLİMASI	QBT 4000-02	220-230V 50/60Hz	4050 W	64,0 Kg	1205x456x290 mm	INOX	4.600 €

### OUTDOOR (DIŞ ORTAM) PANO KLİMALARI (IP65)

AÇIKLAMA	KOD	BESLEME	SOĞUTMA GÜCÜ	AĞIRLIK (KG)	ÖLÇÜLER (YxGxD) mm	RENK	FİYAT
OUTDOOR PANO KLİMASI	OD QBT 350	220-230V 50/60Hz	340 W	24,5 Kg	550x300x270 mm	RAL 7035	1.553 €
OUTDOOR PANO KLİMASI	OD QBT 500	220-230V 50/60Hz	510 W	25,0 Kg	550x300x270 mm	RAL 7035	1.668 €
OUTDOOR PANO KLİMASI	OD QBT 750	220-230V 50/60Hz	720 W	27,0 Kg	640x315x270 mm	RAL 7035	1.840 €
OUTDOOR PANO KLİMASI	OD QBT 1000	220-230V 50/60Hz	1100 W	37,5 Kg	905x406x276 mm	RAL 7035	2.070 €
OUTDOOR PANO KLİMASI	OD QBT 1500	220-230V 50/60Hz	1580 W	38,5 Kg	905x406x276 mm	RAL 7035	2.243 €
OUTDOOR PANO KLİMASI	OD QBT 1700	220-230V 50/60Hz	1720 W	38,5 Kg	905x406x276 mm	RAL 7035	2.473 €
OUTDOOR PANO KLİMASI	OD QBT 2000	220-230V 50/60Hz	1950 W	48,5 Kg	1055x406x310 mm	RAL 7035	2.818 €
OUTDOOR PANO KLİMASI	OD QBT 2500	220-230V 50/60Hz	2570 W	52,5 Kg	1055x406x310 mm	RAL 7035	3.278 €
OUTDOOR PANO KLİMASI	OD QBT 3000	220-230V 50/60Hz	2920 W	57,0 Kg	1055x406x310 mm	RAL 7035	3.738 €
OUTDOOR PANO KLİMASI	OD QBT 3500	220-230V 50/60Hz	3380 W	67,0 Kg	1205x456x350 mm	RAL 7035	4.313 €
OUTDOOR PANO KLİMASI	OD QBT 4000	220-230V 50/60Hz	4050 W	67,0 Kg	1205x456x350 mm	RAL 7035	4.658 €

• Opsiyonel olarak kasa, voltaj, renk ve anıza kontaklı üretim yapılmaktadır.



# ENDÜSTRİYEL FANLAR



**QUICK**  
MODEL UF 123823 BTH  
AC 230 V 50/60Hz  
17/15 W BALL BEARING  
Impedance - Protected  
www.quick.com.tr  
CE

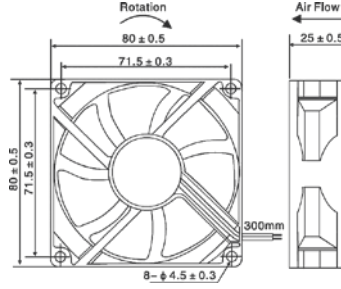

Ölçü : 80 x 80 x 25mm

MODEL	RULMAN	VOLTAJ VDC	AKIM A	GÜÇ W	DEVİR RPM	HAVA DEBİSİ CFM	GÜRÜLTÜ SEVİYESİ dB	AĞIRLIK g	Fiyat (€)
<b>UF-DA802512 BWH</b>	Ball Bearing	12 VDC	0.17	2.04	3000	36.50	32.0	60	12

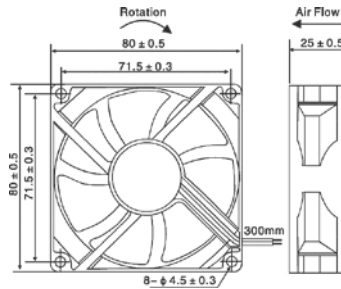

Ölçü : 80 x 80 x 25mm

MODEL	RULMAN	VOLTAJ VDC	AKIM A	GÜÇ W	DEVİR RPM	HAVA DEBİSİ CFM	GÜRÜLTÜ SEVİYESİ dB	AĞIRLIK g	Fiyat (€)
<b>UF-DA802524 BWH</b>	Ball Bearing	24 VDC	0.15	3.8	3000	36.50	32.0	60	12
<b>UF-DA802548 BWH</b>	Ball Bearing	24 VDC	0.15	3.8	3000	36.50	32.0	60	12

YENİ

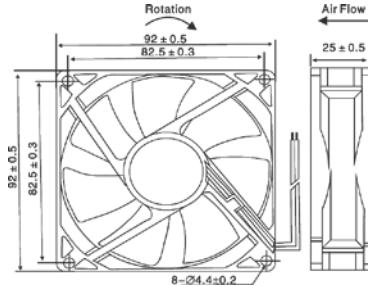

Ölçü : 92 x 92 x 25mm

MODEL	RULMAN	VOLTAJ VDC	AKIM A	GÜÇ W	DEVİR RPM	HAVA DEBİSİ CFM	GÜRÜLTÜ SEVİYESİ dB	AĞIRLIK g	Fiyat (€)
<b>UF-DA922512 BWH</b>	Ball Bearing	12 VDC	0.25	3.00	2800	65.01	40.0	186	13

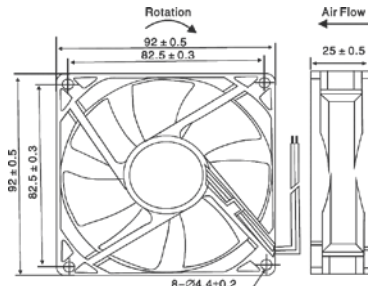

Ölçü : 92 x 92 x 25mm

MODEL	RULMAN	VOLTAJ VDC	AKIM A	GÜÇ W	DEVİR RPM	HAVA DEBİSİ CFM	GÜRÜLTÜ SEVİYESİ dB	AĞIRLIK g	Fiyat (€)
<b>UF-DA922524 BWH</b>	Ball Bearing	24 VDC	0.22	5.28	2800	65.01	40.0	186	13
<b>UF-DA922548 BWH</b>	Ball Bearing	24 VDC	0.22	5.28	2800	65.01	40.0	186	13

YENİ

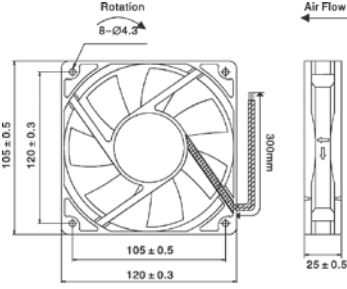

Ölçü : 120 x 120 x 25mm

MODEL	RULMAN	VOLTAJ VDC	AKIM A	GÜÇ W	DEVİR RPM	HAVA DEBİSİ CFM	GÜRÜLTÜ SEVİYESİ dB	AĞIRLIK g	Fiyat (€)
<b>UF-DA122512 BWH</b>	Ball Bearing	12 VDC	0.4	4.80	3000	95.8	38.0	210	<b>13</b>

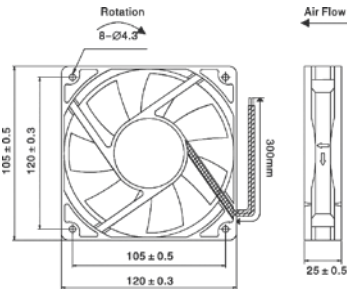

Ölçü : 120 x 120 x 25mm

MODEL	RULMAN	VOLTAJ VDC	AKIM A	GÜÇ W	DEVİR RPM	HAVA DEBİSİ CFM	GÜRÜLTÜ SEVİYESİ dB	AĞIRLIK g	Fiyat (€)
<b>UF-DA122524 BWH</b>	Ball Bearing	24 VDC	0.35	8.40	3000	95.8	38.0	210	<b>13</b>

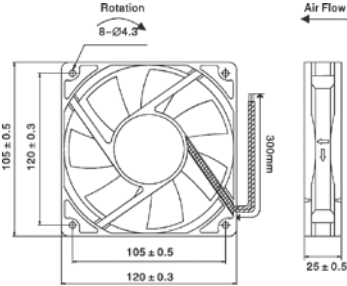

Ölçü : 120 x 120 x 25mm

MODEL	RULMAN	VOLTAJ VDC	AKIM A	GÜÇ W	DEVİR RPM	HAVA DEBİSİ CFM	GÜRÜLTÜ SEVİYESİ dB	AĞIRLIK g	Fiyat (€)
<b>UF-DA122548 BWH</b>	Ball Bearing	48 VDC	0.15	7.20	3000	116.8	44.0	210	<b>13</b>

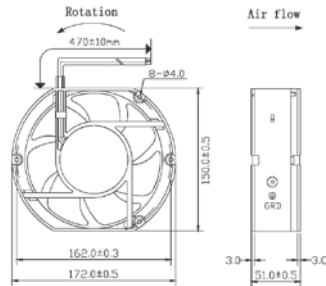

**UF-DA1751B24H**  
Ölçü : 172 x 150 x 51mm

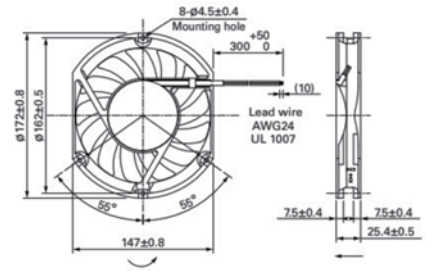

**UF-DA1725B24H**  
Ölçü : 172 x 147 x 25mm

MODEL	RULMAN	VOLTAJ VDC	AKIM A	GÜÇ W	DEVİR RPM	HAVA DEBİSİ CFM	GÜRÜLTÜ SEVİYESİ dB	AĞIRLIK g	Fiyat (€)
<b>UF-DA1751B24H</b>	Ball Bearing	24 VDC	1.5	36	3300	226.50	55.8	720	<b>35</b>
<b>UF-DA1725B24H</b>	Ball Bearing	24 VDC	1.5	36	3300	226.50	55.8	720	<b>35</b>

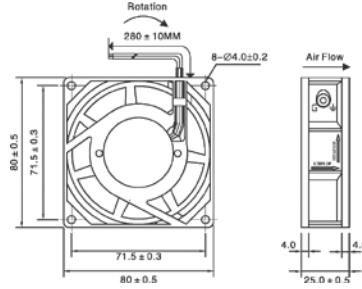

Ölçü : 80 x 80 x 25mm

MODEL	RULMAN	VOLTAJ VAC	FREKANS Hz	AKIM A	GÜÇ W	DEVİR RPM	HAVA DEBİSİ CFM	GÜRÜLTÜ SEVİYESİ dB	AĞIRLIK g	Fiyat (€)
<b>UF-802523 BWH</b>	Ball Bearing	230 VAC	50/60	0.08	15 / 13	2600/3000	21/24	33/35	240	7

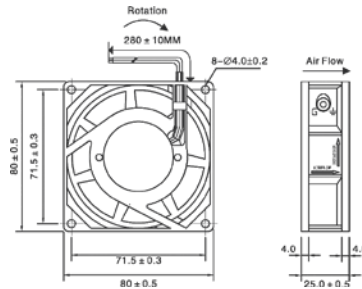

Ölçü : 80 x 80 x 25mm

MODEL	RULMAN	VOLTAJ VAC	FREKANS Hz	AKIM A	GÜÇ W	DEVİR RPM	HAVA DEBİSİ CFM	GÜRÜLTÜ SEVİYESİ dB	AĞIRLIK g	Fiyat (€)
<b>UF-802523 SWH</b>	Sleeve Bearing	230 VAC	50/60	0.08	15 / 13	2600/3000	21/24	33/35	240	6

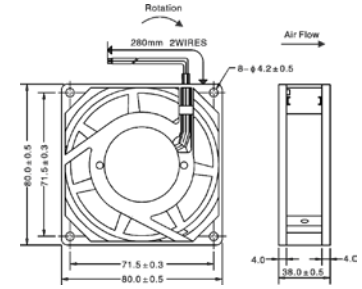

Ölçü : 80 x 80 x 38mm

MODEL	RULMAN	VOLTAJ VAC	FREKANS Hz	AKIM A	GÜÇ W	DEVİR RPM	HAVA DEBİSİ CFM	GÜRÜLTÜ SEVİYESİ dB	AĞIRLIK g	Fiyat (€)
<b>UF-803823 BWH</b>	Ball Bearing	230 VAC	50/60	0.08	15 / 13	2400/2800	23/28	34/36	290	7

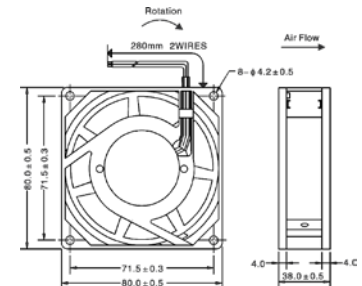

Ölçü : 80 x 80 x 38mm

MODEL	RULMAN	VOLTAJ VAC	FREKANS Hz	AKIM A	GÜÇ W	DEVİR RPM	HAVA DEBİSİ CFM	GÜRÜLTÜ SEVİYESİ dB	AĞIRLIK g	Fiyat (€)
<b>UF-803823 SWH</b>	Sleeve Bearing	230 VAC	50/60	0.08	15 / 13	2400/2800	23/28	34/36	290	6

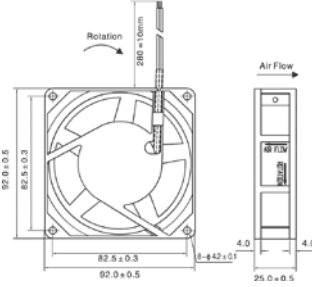

Ölçü : 92 x 92 x 25mm

MODEL	RULMAN	VOLTAJ VAC	FREKANS Hz	AKIM A	GÜÇ W	DEVİR RPM	HAVA DEBİSİ CFM	GÜRÜLTÜ SEVİYESİ dB	AĞIRLIK g	Fiyat (€)
<b>UF-922523 BWH</b>	Ball Bearing	230 VAC	50/60	0.08	17/15	2500/3000	24/29	33/35	280	<b>8</b>

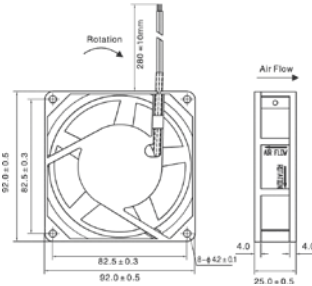

Ölçü : 92 x 92 x 25mm

MODEL	RULMAN	VOLTAJ VAC	FREKANS Hz	AKIM A	GÜÇ W	DEVİR RPM	HAVA DEBİSİ CFM	GÜRÜLTÜ SEVİYESİ dB	AĞIRLIK g	Fiyat (€)
<b>UF-922523 SWH</b>	Sleeve Bearing	230 VAC	50/60	0.08	17/15	2500/3000	24/29	33/35	280	<b>7</b>

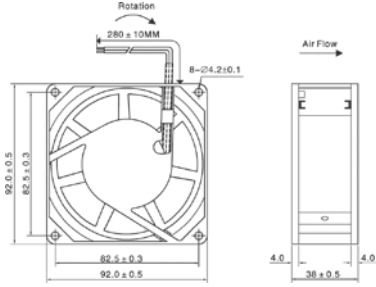

Ölçü : 92 x 92 x 38mm

MODEL	RULMAN	VOLTAJ VAC	FREKANS Hz	AKIM A	GÜÇ W	DEVİR RPM	HAVA DEBİSİ CFM	GÜRÜLTÜ SEVİYESİ dB	AĞIRLIK g	Fiyat (€)
<b>UF-923823 BWH</b>	Ball Bearing	230 VAC	50/60	0.08	17/15	2400/2800	39/46	34/36	340	<b>8</b>

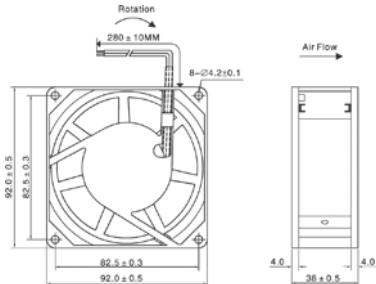

Ölçü : 92 x 92 x 38mm

MODEL	RULMAN	VOLTAJ VAC	FREKANS Hz	AKIM A	GÜÇ W	DEVİR RPM	HAVA DEBİSİ CFM	GÜRÜLTÜ SEVİYESİ dB	AĞIRLIK g	Fiyat (€)
<b>UF-923823 SWH</b>	Sleeve Bearing	230 VAC	50/60	0.08	17/15	2400/2800	39/46	34/36	340	<b>7</b>

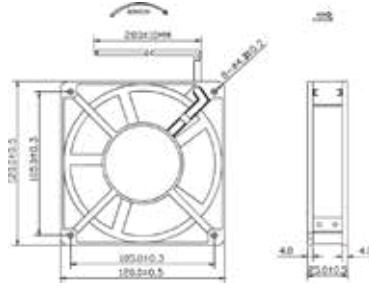

Ölçü : 120 x 120 x 25mm

MODEL	RULMAN	VOLTAJ VAC	FREKANS Hz	AKIM A	GÜÇ W	DEVİR RPM	HAVA DEBİSİ CFM	GÜRÜLTÜ SEVİYESİ dB	AĞIRLIK g	Fiyat (€)
<b>UF-122523 BWH</b>	Ball Bearing	230 VAC	50/60	0.08	15/13	2300/2700	58/66	35/37	320	<b>8</b>

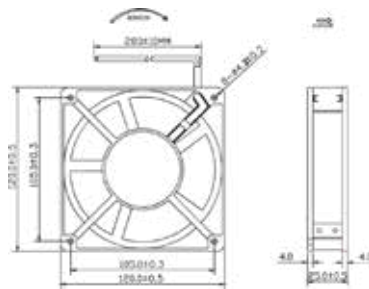

Ölçü : 120 x 120 x 25mm

MODEL	RULMAN	VOLTAJ VAC	FREKANS Hz	AKIM A	GÜÇ W	DEVİR RPM	HAVA DEBİSİ CFM	GÜRÜLTÜ SEVİYESİ dB	AĞIRLIK g	Fiyat (€)
<b>UF-122523 SWH</b>	Sleeve Bearing	230 VAC	50/60	0.08	15/13	2300/2700	58/66	35/37	320	<b>6</b>

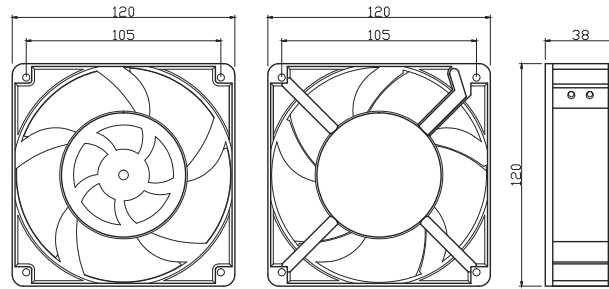

Ölçü : 120 x 120 x 38mm

MODEL	RULMAN	VOLTAJ VAC	FREKANS Hz	AKIM A	GÜÇ W	DEVİR RPM	HAVA DEBİSİ CFM	GÜRÜLTÜ SEVİYESİ dB	AĞIRLIK g	Fiyat (€)
<b>UF-123823 BWH</b>	Ball Bearing	230 VAC	50/60	0.14	17/15	2600/3000	80/91	30/34	530	<b>8</b>

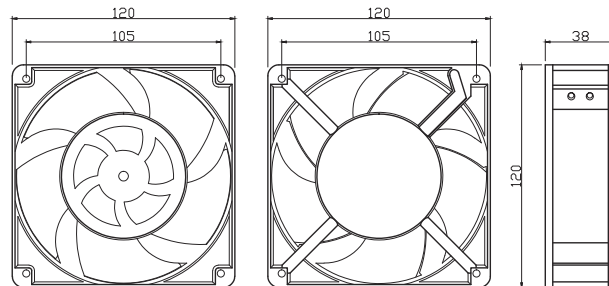

Ölçü : 120 x 120 x 38mm

MODEL	RULMAN	VOLTAJ VAC	FREKANS Hz	AKIM A	GÜÇ W	DEVİR RPM	HAVA DEBİSİ CFM	GÜRÜLTÜ SEVİYESİ dB	AĞIRLIK g	Fiyat (€)
<b>UF-123823 BTH</b>	Ball Bearing	230 VAC	50/60	0.14	17/15	2600/3000	80/91	30/34	530	<b>8</b>

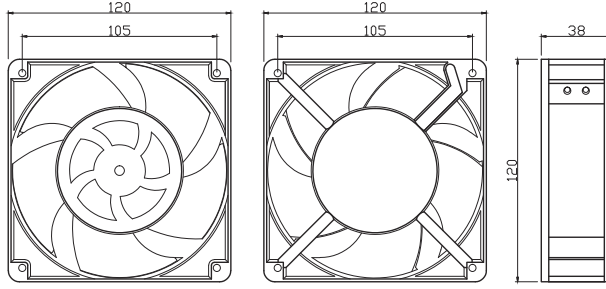

Ölçü : 120 x 120 x 38mm

MODEL	RULMAN	VOLTAJ VAC	FREKANS Hz	AKIM A	GÜÇ W	DEVİR RPM	HAVA DEBİSİ CFM	GÜRÜLTÜ SEVİYESİ dB	AĞIRLIK g	Fiyat (€)
<b>UF-123823 SWH</b>	Sleeve Bearing	230 VAC	50/60	0.14	17/15	2600/3000	80/91	30/34	530	<b>6</b>

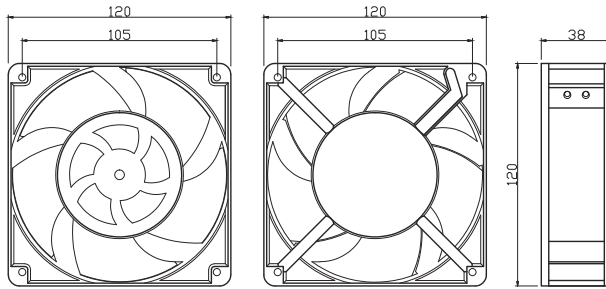

Ölçü : 120 x 120 x 38mm

MODEL	RULMAN	VOLTAJ VAC	FREKANS Hz	AKIM A	GÜÇ W	DEVİR RPM	HAVA DEBİSİ CFM	GÜRÜLTÜ SEVİYESİ dB	AĞIRLIK g	Fiyat (€)
<b>UF-123823 STH</b>	Sleeve Bearing	230 VAC	50/60	0.14	17/15	2600/3000	80/91	30/34	530	<b>6</b>

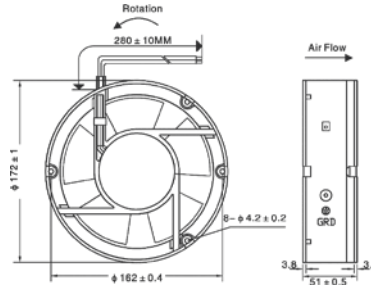

Ölçü : Ø172 x 51mm

MODEL	RULMAN	VOLTAJ VAC	FREKANS Hz	AKIM A	GÜÇ W	DEVİR RPM	HAVA DEBİSİ CFM	GÜRÜLTÜ SEVİYESİ dB	AĞIRLIK g	Fiyat (€)
<b>UF-172523 BWH</b>	Ball Bearing	230 VAC	50/60	0.23	38/36	2600/3000	170/196	49/56	800	<b>20</b>

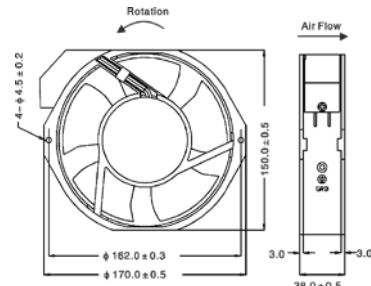

Ölçü : 170 x 150 x 38mm

MODEL	RULMAN	VOLTAJ VAC	FREKANS Hz	AKIM A	GÜÇ W	DEVİR RPM	HAVA DEBİSİ CFM	GÜRÜLTÜ SEVİYESİ dB	AĞIRLIK g	Fiyat (€)
<b>UF-173823 BWH</b>	Ball Bearing	230 VAC	50/60	0.17/0.16	27/26	2500/3000	166/198	57/61	760	<b>20</b>

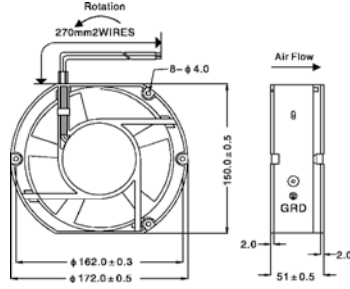

Ölçü : 172 x 150 x 51mm

MODEL	RULMAN	VOLTAJ VAC	FREKANS Hz	AKIM A	GÜÇ W	DEVİR RPM	HAVA DEBİSİ CFM	GÜRÜLTÜ SEVİYESİ dB	AĞIRLIK g	Fiyat (€)
<b>UF-175123 BWH</b>	Ball Bearing	230 VAC	50/60	0.23	38/36	2600/3000	170/196	49/56	800	<b>20</b>

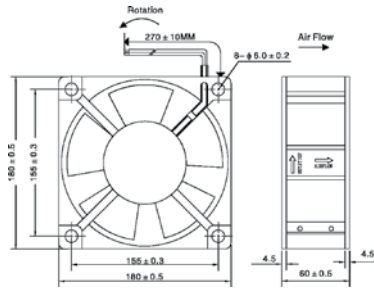

Ölçü : 180 x 180 x 60mm

MODEL	RULMAN	VOLTAJ VAC	FREKANS Hz	AKIM A	GÜÇ W	DEVİR RPM	HAVA DEBİSİ CFM	GÜRÜLTÜ SEVİYESİ dB	AĞIRLIK g	Fiyat (€)
<b>UF-186023 BWH</b>	Ball Bearing	230 VAC	50/60	0.35	50	2700	350	60	950	<b>30</b>

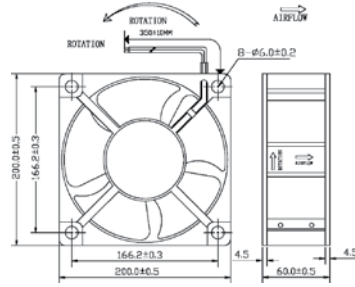

Ölçü : 200 x 200 x 60mm

MODEL	RULMAN	VOLTAJ VAC	FREKANS Hz	AKIM A	GÜÇ W	DEVİR RPM	HAVA DEBİSİ CFM	GÜRÜLTÜ SEVİYESİ dB	AĞIRLIK g	Fiyat (€)
<b>UF-2006023 BWH</b>	Ball Bearing	230 VAC	50/60	0.45	65	2700	420	54	1540	<b>35</b>

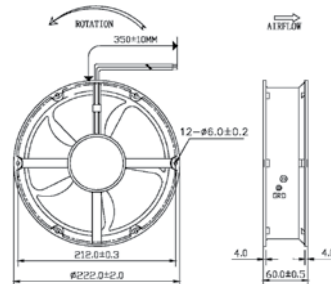

Ölçü : Ø222 x 60mm

MODEL	RULMAN	VOLTAJ VAC	FREKANS Hz	AKIM A	GÜÇ W	DEVİR RPM	HAVA DEBİSİ CFM	GÜRÜLTÜ SEVİYESİ dB	AĞIRLIK g	Fiyat (€)
<b>UF-2206023 BWH</b>	Ball Bearing	230 VAC	50/60	0.45	65	2700	420	54	1540	<b>30</b>



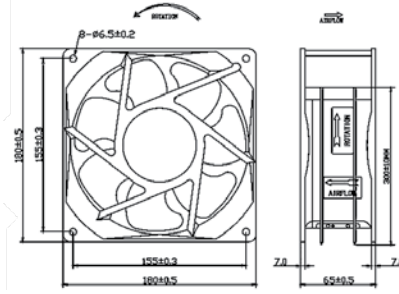

Ölçü : 180 x 180 x 65mm

MODEL	RULMAN	VOLTAJ VAC	FREKANS Hz	AKIM A	GÜÇ W	DEVİR RPM	HAVA DEBİSİ CFM	GÜRÜLTÜ SEVİYESİ dB	AĞIRLIK g	Fiyat (€)
<b>UF-1806523 BWH</b>	Ball Bearing	230 VAC	50/60	0.26/0.38	60/85	2850/3250	400/460	61/65	1200	<b>45</b>

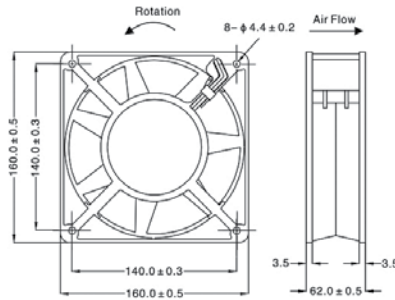

Ölçü : 160 x 160 x 62mm

MODEL	RULMAN	VOLTAJ VAC	FREKANS Hz	AKIM A	GÜÇ W	DEVİR RPM	HAVA DEBİSİ CFM	GÜRÜLTÜ SEVİYESİ dB	AĞIRLIK g	Fiyat (€)
<b>UF-166223H-C</b>	Ball Bearing	230 VAC	50/60	0.2	42	2600/3000	255/295	55/58	1200	<b>45</b>

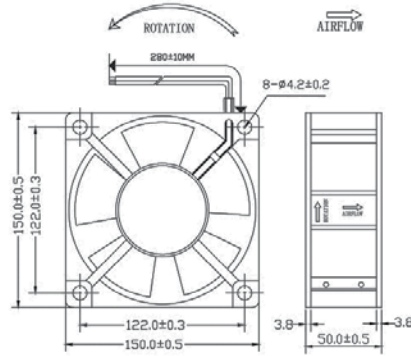

Ölçü : 150 x 150 x 50mm

MODEL	RULMAN	VOLTAJ VAC	FREKANS Hz	AKIM A	GÜÇ W	DEVİR RPM	HAVA DEBİSİ CFM	GÜRÜLTÜ SEVİYESİ dB	AĞIRLIK g	Fiyat (€)
<b>UF-155023 BWH</b>	Ball Bearing	230 VAC	50/60	0.23	38/36	2600/3000	170/196	49/56	800	<b>30</b>

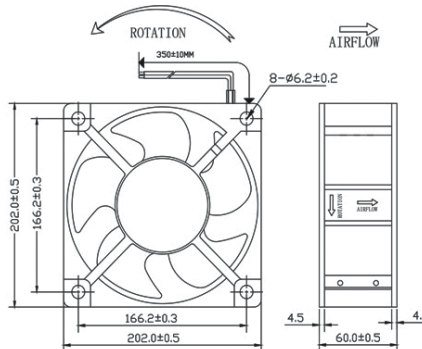

Ölçü : 200 x 200 x 60mm

MODEL	RULMAN	VOLTAJ VDC	FREKANS Hz	AKIM A	GÜÇ W	DEVİR RPM	HAVA DEBİSİ CFM	GÜRÜLTÜ SEVİYESİ dB	AĞIRLIK g	Fiyat (€)
<b>UF-DA20060B24H</b>	Ball Bearing	24 VDC	50/60	0.5	12	3000	488	61	1200	<b>55</b>

# ENDÜSTRİYEL FANLAR



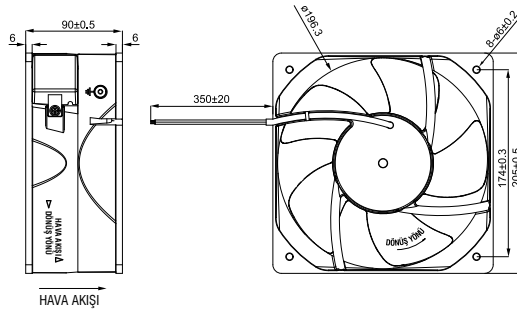

Ölçü (mm) : 205 x 205 x 90

Thermally-Protected



MODEL	VOLTAJ (VAC)	FREKANS (Hz)	Güç (W)	AKIM (A)	HIZ (d/d)	m <sup>3</sup> /h	(CFM)	mmH <sub>2</sub> O	inchH <sub>2</sub> O	(dB)	FİYAT €
UF20JC23-H	230V	50	70	0.32	2800	1020	600	20.3	0.80	67	90
		60	98	0.45	3200	1158	680	19.8	0.77	71	

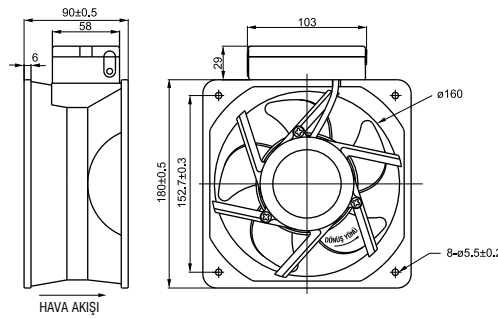

Ölçü (mm) : 180 x 180 x 90

Thermally-Protected



MODEL	VOLTAJ (VAC)	FREKANS (Hz)	Güç (W)	AKIM (A)	HIZ (d/d)	m <sup>3</sup> /h	(CFM)	mmH <sub>2</sub> O	inchH <sub>2</sub> O	(dB)	FİYAT €
UF18JC23-H	230V	50	75	0.42	2850	660	390	20	0.78	54	85
		60	72	0.31	3400	780	460	27	1.06	59	

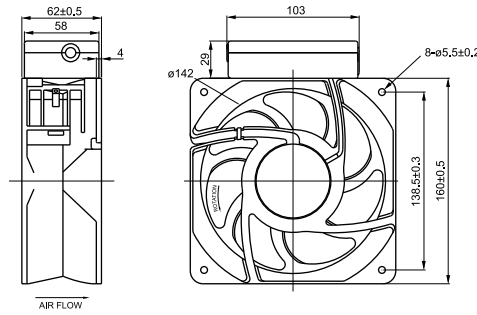

Ölçü (mm) : 160 x 160 x 62

Thermally-Protected



MODEL	VOLTAJ (VAC)	FREKANS (Hz)	Güç (W)	AKIM (A)	HIZ (d/d)	m <sup>3</sup> /h	(CFM)	mmH <sub>2</sub> O	inchH <sub>2</sub> O	(dB)	FİYAT €
UF16FC23-H	230V	50	46	0.22	2850	378	222	13.5	0.53	52	75
		60	41	0.17	3400	450	265	18.2	0.72	56	

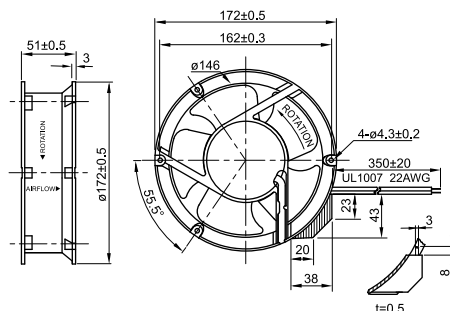
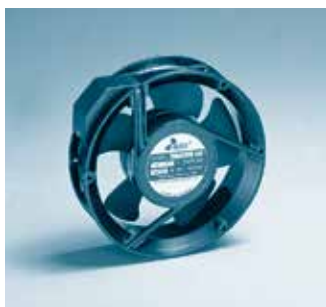

Ölçü (mm) : Ø172x51

Thermally-Protected



MODEL	VOLTAJ (VAC)	FREKANS (Hz)	Güç (W)	AKIM (A)	HIZ (d/d)	m <sup>3</sup> /h	(CFM)	mmH <sub>2</sub> O	inchH <sub>2</sub> O	(dB)	FİYAT €
UF17PC23-H	230V	50	29	0.12	2850	348	205	16	0.63	50	32
		60	29	0.12	3400	384	226	20	0.79	55	

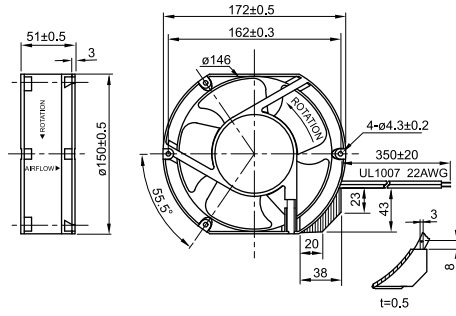
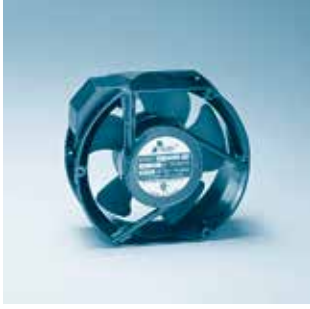

Ölçü (mm) : 172 x 150 x 51

Thermally-Protected



MODEL	VOLTAJ (VAC)	FREKANS (Hz)	Güç (W)	AKIM (A)	HIZ (d/d)	m <sup>3</sup> /h	(CFM)	mmH <sub>2</sub> O	inchH <sub>2</sub> O	(dB)	FİYAT €
UF15PC23-H	230V	50	29	0.12	2850	348	205	16	0.63	53	40
		60	29	0.12	3400	384	226	20	0.79	58	

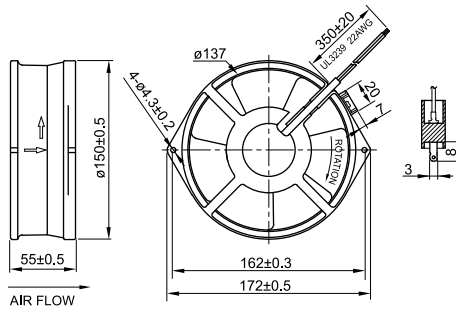

Ölçü (mm) : 172 x 150 x 55

Thermally-Protected



MODEL	VOLTAJ (VAC)	FREKANS (Hz)	Güç (W)	AKIM (A)	HIZ (d/d)	m <sup>3</sup> /h	(CFM)	mmH <sub>2</sub> O	inchH <sub>2</sub> O	(dB)	FİYAT €
UF15KM23-H	230V	50	42	0.25	2800	360	195	14	0.55	49	45
		60	42	0.23	3250	390	230	16	0.63	53	

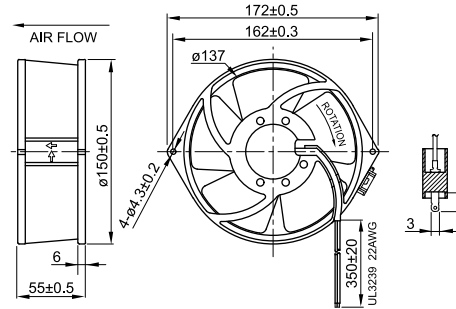
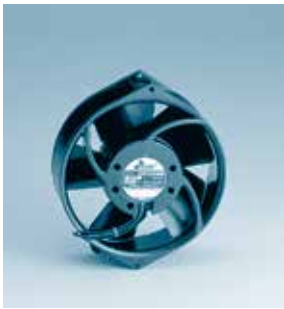

Ölçü (mm) : 172 x 150 x 55

Thermally-Protected



MODEL	VOLTAJ (VAC)	FREKANS (Hz)	Güç (W)	AKIM (A)	HIZ (d/d)	m <sup>3</sup> /h	(CFM)	mmH <sub>2</sub> O	inchH <sub>2</sub> O	(dB)	FİYAT €
UF15KMR23-H	230V	50	45	0.27	2750	384	225	12.5	0.50	58	45
		60	45	0.25	3150	432	255	12.5	0.50	61	

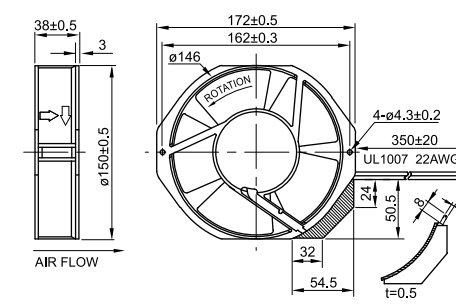

Ölçü (mm) : 172 x 150 x 38

Thermally-Protected



MODEL	VOLTAJ (VAC)	FREKANS (Hz)	Güç (W)	AKIM (A)	HIZ (d/d)	m <sup>3</sup> /h	(CFM)	mmH <sub>2</sub> O	inchH <sub>2</sub> O	(dB)	FİYAT €
UF15AC23-H	230V	50	27	0.11	2850	300	177	17.0	0.67	54	40
		60	26	0.11	3400	360	212	19.0	0.75	58	
UF15AC11-H	115V	50	29	0.25	2850	300	177	17.0	0.67	54	60
		60	28	0.23	3400	360	212	19.0	0.75	58	

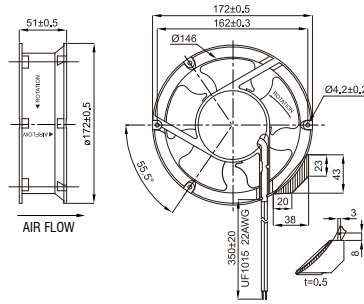

Ölçü (mm) : Ø172 x 172 x 51

Impedance-Protected



MODEL	VOLTAJ (VAC)	FREKANS (Hz)	Güç (W)	AKIM (A)	HIZ (d/d)	m <sup>3</sup> /h	(CFM)	mmH <sub>2</sub> O	inchH <sub>2</sub> O	(dB)	FİYAT €
UF17P23-H	230V	50	35	0.23	2750	280	170	10.5	0.42	49	30
		60	30	0.18	3100	330	195	9.5	0.38	53	

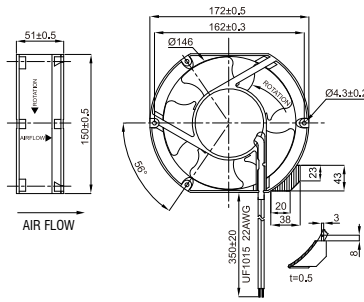

Ölçü (mm) : 172 x 150 x 51

Impedance-Protected



MODEL	VOLTAJ (VAC)	FREKANS (Hz)	Güç (W)	AKIM (A)	HIZ (d/d)	m <sup>3</sup> /h	(CFM)	mmH <sub>2</sub> O	inchH <sub>2</sub> O	(dB)	FİYAT €
UF15P23-H	230V	50	35	0.23	2750	288	170	10.5	0.42	50	30
		60	30	0.18	3100	330	195	9.5	0.38	55	

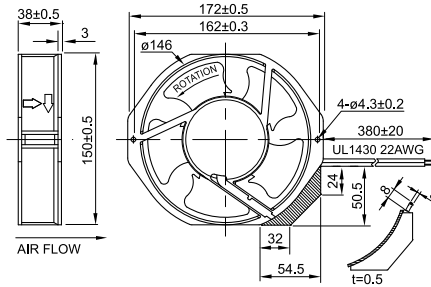

Ölçü (mm) : 172 x 150 x 38

Impedance-Protected



MODEL	VOLTAJ (VAC)	FREKANS (Hz)	Güç (W)	AKIM (A)	HIZ (d/d)	m <sup>3</sup> /h	(CFM)	mmH <sub>2</sub> O	inchH <sub>2</sub> O	(dB)	FİYAT €
UF15A23-H	230V	50	39	0.25	2750	282	166	11	0.43	50	30
		60	31	0.19	3200	336	198	10	0.40	55	

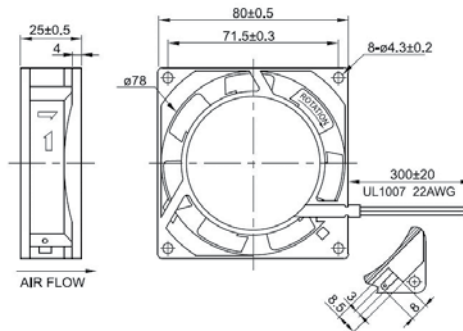

Ölçü (mm) : 80 x 80 x 25

Impedance-Protected



MODEL	VOLTAJ (VAC)	FREKANS (Hz)	Güç (W)	AKIM (A)	HIZ (d/d)	m <sup>3</sup> /h	CFM	mmH <sub>2</sub> O	inchH <sub>2</sub> O	(dB)	FİYAT (€)
UF80B23-H	230V	50/60	16	0.08	2600	32	19	3.6	0.14	32	13
			14	0.07	3100	40	23	5.5	0.22	35	

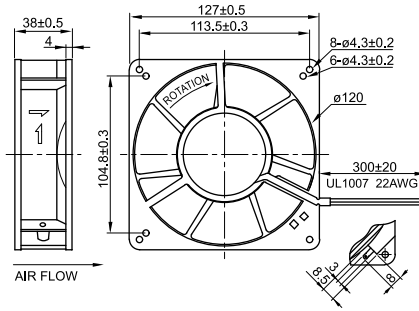

Ölçü (mm) : 127 x 127 x 38

Impedance-Protected



MODEL	VOLTAJ (VAC)	FREKANS (Hz)	Güç (W)	AKIM (A)	HIZ (d/d)	m <sup>3</sup> /h	(CFM)	mmH <sub>2</sub> O	inchH <sub>2</sub> O	(dB)	FİYAT €
UF13A23-H	230V	50	17	0.10	2700	174	103	7.3	0.29	46	15
		60	15	0.09	3000	204	120	2.8	0.11	50	

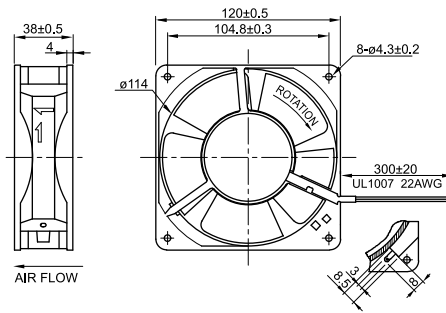

Ölçü (mm) : 120x120x38

Impedance-Protected



MODEL	VOLTAJ (VAC)	FREKANS (Hz)	Güç (W)	AKIM (A)	HIZ (d/d)	m <sup>3</sup> /h	(CFM)	mmH <sub>2</sub> O	inchH <sub>2</sub> O	(dB)	FİYAT €
UF12AR23-H	230V	50	17	0.10	2700	144	85	8.0	0.32	45	12
		60	15	0.09	3100	228	99	8.5	0.33	47	

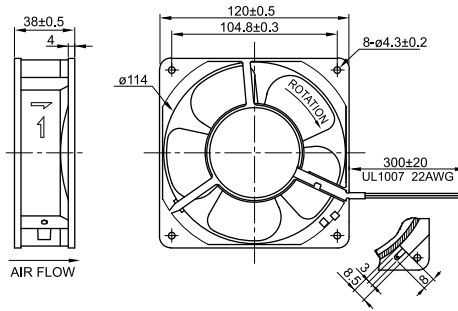

Ölçü (mm) : 120x120x38

Impedance-Protected



MODEL	VOLTAJ (VAC)	FREKANS (Hz)	Güç (W)	AKIM (A)	HIZ (d/d)	m <sup>3</sup> /h	(CFM)	mmH <sub>2</sub> O	inchH <sub>2</sub> O	(dB)	FİYAT €
UF12A23-H	230V	50	17	0.14	2700	156	92	8.0	0.32	42	12
		60	15	0.11	3100	180	106	8.0	0.32	46	

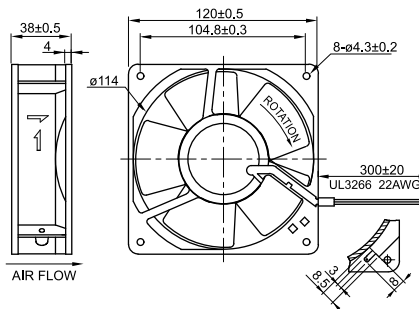

Ölçü (mm) : 120x120x38

Impedance-Protected



MODEL	VOLTAJ (VAC)	FREKANS (Hz)	Güç (W)	AKIM (A)	HIZ (d/d)	m <sup>3</sup> /h	(CFM)	mmH <sub>2</sub> O	inchH <sub>2</sub> O	(dB)	FİYAT €
UF12AM23-H	230V	50	17	0.10	2700	150	89	6.5	0.26	42	20
		60	15	0.09	3100	174	103	6.0	0.24	46	

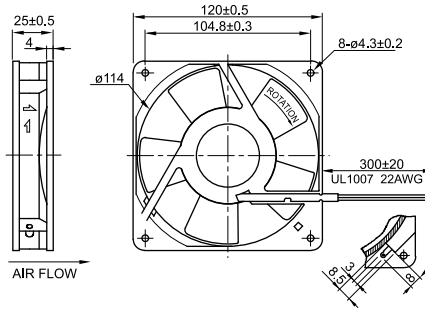

Ölçü (mm) : 120x120x25

Impedance-Protected



MODEL	VOLTAJ (VAC)	FREKANS (Hz)	Güç (W)	AKIM (A)	HIZ (d/d)	m <sup>3</sup> /h	(CFM)	mmH <sub>2</sub> O	inchH <sub>2</sub> O	(dB)	FİYAT €
UF12B23-H	230V	50	16	0.08	2400	108	62	4.7	0.19	38	12
		60	14	0.07	2900	126	75	4.7	0.19	42	

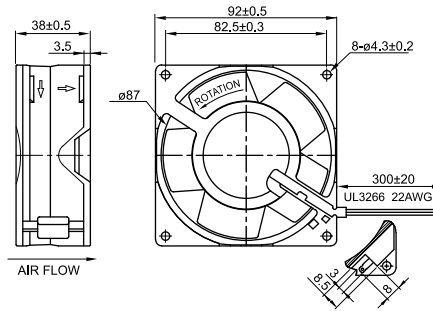

Ölçü (mm) : 92x92x38

Impedance-Protected



MODEL	VOLTAJ (VAC)	FREKANS (Hz)	Güç (W)	AKIM (A)	HIZ (d/d)	m <sup>3</sup> /h	(CFM)	mmH <sub>2</sub> O	inchH <sub>2</sub> O	(dB)	FİYAT €
UF92AM23-H	230V	50	12	0.06	2700	75	44	6.0	0.24	37	21
		60	11	0.05	3200	87	51	7.5	0.30	42	

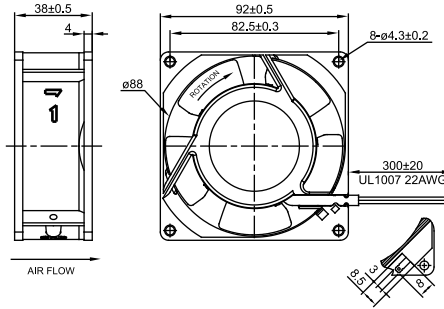

Ölçü (mm) : 92x92x38

Impedance-Protected



MODEL	VOLTAJ (VAC)	FREKANS (Hz)	Güç (W)	AKIM (A)	HIZ (d/d)	m <sup>3</sup> /h	(CFM)	mmH <sub>2</sub> O	inchH <sub>2</sub> O	(dB)	FİYAT €
UF92A23-H	230V	50	16	0.12	2800	66	38	5.6	0.22	34	12
		60	12	0.09	3300	78	46	8.1	0.32	38	

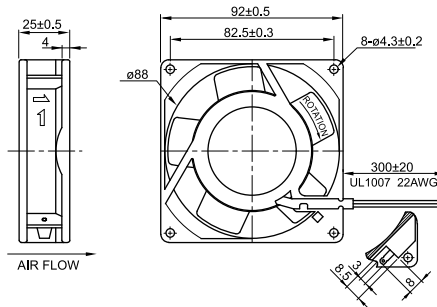

Ölçü (mm) : 92x92x25

Thermally-Protected



MODEL	VOLTAJ (VAC)	FREKANS (Hz)	Güç (W)	AKIM (A)	HIZ (d/d)	m <sup>3</sup> /h	(CFM)	mmH <sub>2</sub> O	inchH <sub>2</sub> O	(dB)	FİYAT €
UF92B23-H	230V	50	16	0.08	2500	56	33	4.2	0.17	32	12
		60	14	0.07	3000	68	40	6.1	0.24	36	

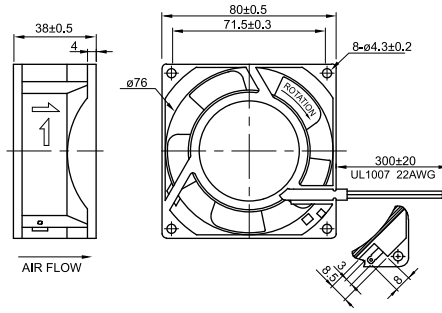

Ölçü (mm) : 80x80x38

Impedance-Protected



MODEL	VOLTAJ (VAC)	FREKANS (Hz)	Güç (W)	AKIM (A)	HIZ (d/d)	m <sup>3</sup> /h	(CFM)	mmH <sub>2</sub> O	inchH <sub>2</sub> O	(dB)	FİYAT €
UF80A23-H	230V	50	14	0.07	2500	40.8	24	3.6	0.14	32	13
		60	12	0.06	3000	50	30	5.3	0.21	36	

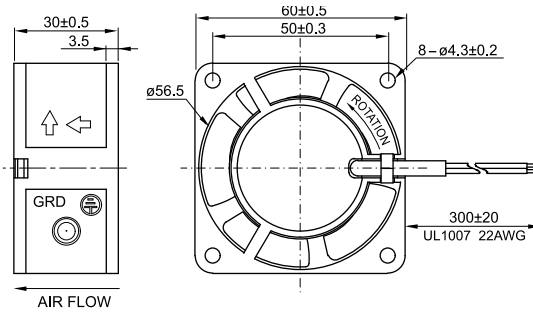

Ölçü (mm) : 60x60x30

Impedance-Protected



MODEL	VOLTAJ (VAC)	FREKANS (Hz)	Güç (W)	AKIM (A)	HIZ (d/d)	m <sup>3</sup> /h	(CFM)	mmH <sub>2</sub> O	inchH <sub>2</sub> O	(dB)	FİYAT €
UF60D23-H	230V	50	5	0.040	2400	14	8.10	1.8	0.07	27	13
		60	4	0.032	3000	18	10.24	2.8	0.11	28	

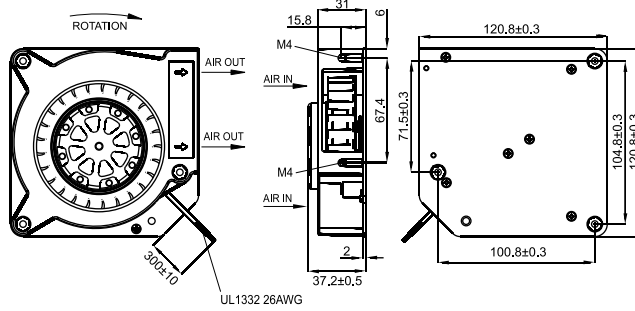

Ölçü (mm) : 120.8 x 120.8 x 37.2

Impedance-Protected



MODEL	VOLTAJ (VAC)	FREKANS (Hz)	Güç (W)	AKIM (A)	HIZ (d/d)	m <sup>3</sup> /h	(CFM)	mmH <sub>2</sub> O	inchH <sub>2</sub> O	(dB)	FİYAT €
UF90DPB23H	230V	50	19	0.11	2500	35	20	10	0.40	49	35
		60	18	0.10	2700	36	21	13	0.50	51	

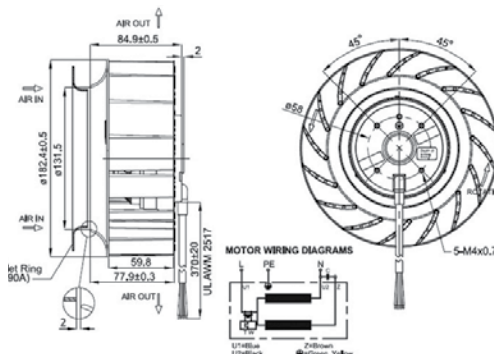

Ölçü (mm) : Ø182.4 x 84.9

Thermally-Protected



MODEL	VOLTAJ (VAC)	FREKANS (Hz)	Güç (W)	AKIM (A)	HIZ (d/d)	m <sup>3</sup> /h	CFM	mmH <sub>2</sub> O	inchH <sub>2</sub> O	(dB)	FİYAT (€)
UF180APA23H1C2A	230V	50	70	0.30	2300	510	300	25	1.0	63	68
		60	81	0.35	2400	510	300	34	1.3	63	

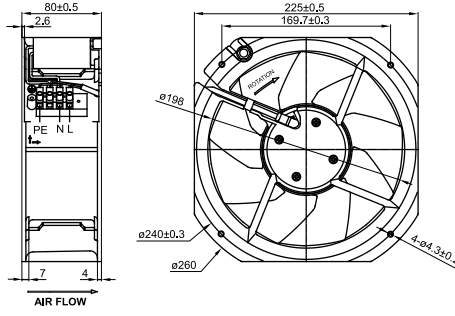

Ölçü (mm) : 225x225x80

Thermally-Protected



MODEL	VOLTAJ (VAC)	FREKANS (Hz)	Güç (W)	AKIM (A)	HIZ (d/d)	m <sup>3</sup> /h	(CFM)	mmH <sub>2</sub> O	inchH <sub>2</sub> O	(dB)	FİYAT €
UF200BMB23H1C2A	230V	50	74	0.29	2550	900	530	17	0.67	59	70
		60	80	0.35	2800	1020	600	14	0.55	61	

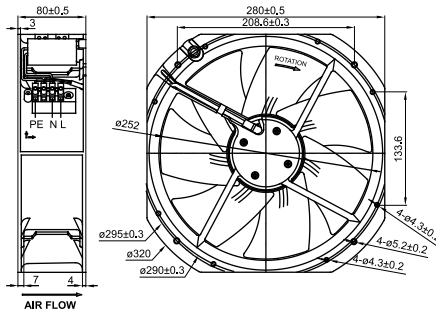

Ölçü (mm) : 280x280x80

Thermally-Protected



MODEL	VOLTAJ (VAC)	FREKANS (Hz)	Güç (W)	AKIM (A)	HIZ (d/d)	m <sup>3</sup> /h	(CFM)	mmH <sub>2</sub> O	inchH <sub>2</sub> O	(dB)	FİYAT €
UF250BMB23H1C2A	230V	50	119	0.59	2550	1860	1090	20.0	0.78	68	90
		60	158	0.82	2700	1920	1130	16.5	0.65	70	

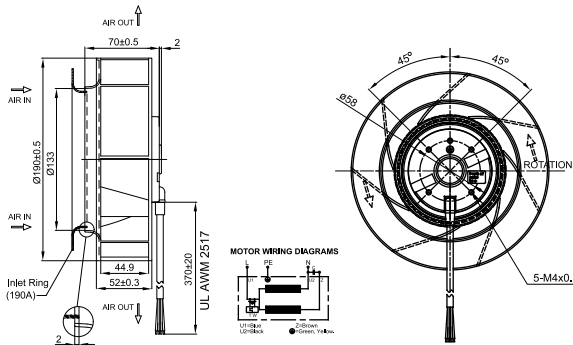

Ölçü (mm) : Ø190 x 70

Thermally-Protected



MODEL	VOLTAJ (VAC)	FREKANS (Hz)	Güç (W)	AKIM (A)	HIZ (d/d)	m <sup>3</sup> /h	(CFM)	mmH <sub>2</sub> O	inchH <sub>2</sub> O	(dB)	FİYAT €
UF190APA23H1C2A	230V	50	57	0.23	2500	570	335	25	1.0	60	55
		60	72	0.30	2700	624	370	30	1.2	63	

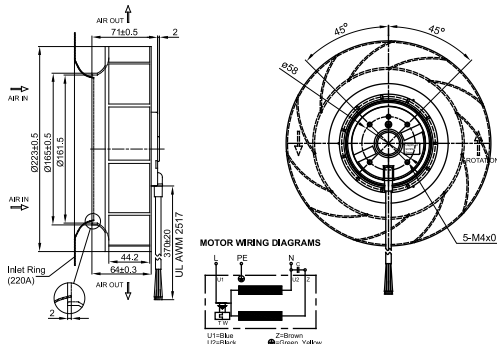

Ölçü (mm) : Ø223 x 71

Thermally-Protected



MODEL	VOLTAJ (VAC)	FREKANS (Hz)	Güç (W)	AKIM (A)	HIZ (d/d)	m <sup>3</sup> /h	(CFM)	mmH <sub>2</sub> O	inchH <sub>2</sub> O	(dB)	FİYAT €
UF220APA23H2C2A	230V	50	90	0.35	2500	850	500	35	1.4	65	70
		60	117	0.39	2650	900	530	38	1.7	70	

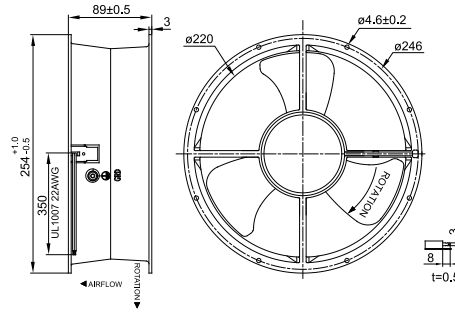
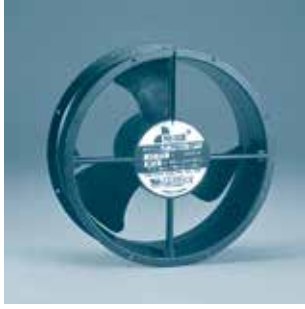

Ölçü (mm) : Ø 254 X 89

Thermally-Protected



MODEL	VOLTAJ (VAC)	FREKANS (Hz)	Güç (W)	AKIM (A)	HIZ (d/d)	m <sup>3</sup> /h	(CFM)	mmH <sub>2</sub> O	inchH <sub>2</sub> O	(dB)	FİYAT €
UF25GCA23-H	230V	50	60	0.25	2500	1110	650	11.7	0.46	61	90
		60	75	0.35	2600	1158	680	9.40	0.37	62	

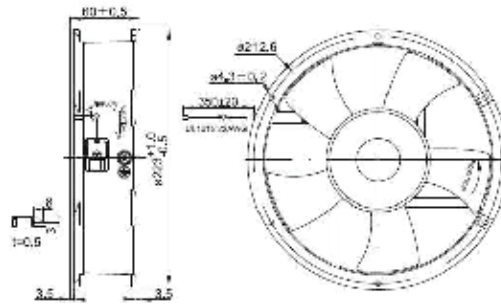

Ölçü (mm) : Ø 223 x 60

Thermally-Protected



MODEL	VOLTAJ (VAC)	FREKANS (Hz)	Güç (W)	AKIM (A)	HIZ (d/d)	m <sup>3</sup> /h	(CFM)	mmH <sub>2</sub> O	inchH <sub>2</sub> O	(dB)	FİYAT €
UF22F23H	230V	50	47	0.35	2700	660	400	10.9	0.43	57	40
		60	47	0.35	2700	660	400	10.9	0.43	57	

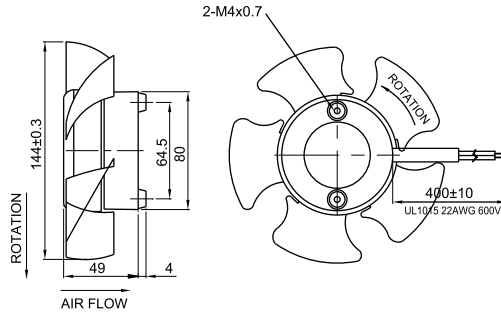

Ölçü (mm) : Ø 144 x 53

Impedance-Protected



MODEL	VOLTAJ (VAC)	FREKANS (Hz)	Güç (W)	AKIM (A)	HIZ (d/d)	m <sup>3</sup> /h	(CFM)	mmH <sub>2</sub> O	inchH <sub>2</sub> O	(dB)	FİYAT €
UF15PE23H	230V	50	36	0.24	2650	272	160	4.06	0.16	48	50
		60	33	0.20	2950	306	180	4.57	0.18	53	

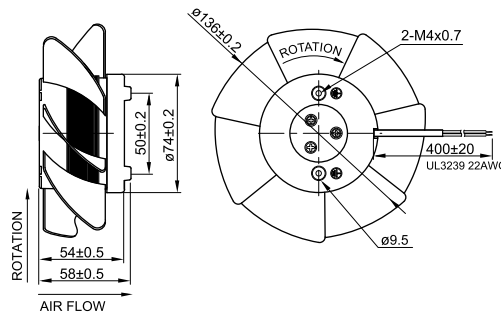
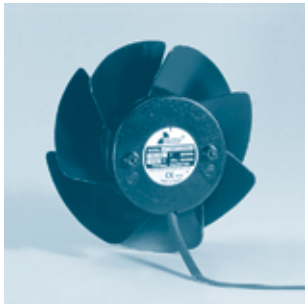

Ölçü (mm) : Ø 136 x 58

Thermally-Protected



MODEL	VOLTAJ (VAC)	FREKANS (Hz)	Güç (W)	AKIM (A)	HIZ (d/d)	m <sup>3</sup> /h	(CFM)	mmH <sub>2</sub> O	inchH <sub>2</sub> O	(dB)	FİYAT €
UF15KME23-H	230V	50	42	0.25	2800	330	195	14	0.55	45	80
		60	42	0.23	3250	390	230	16	0.63	50	

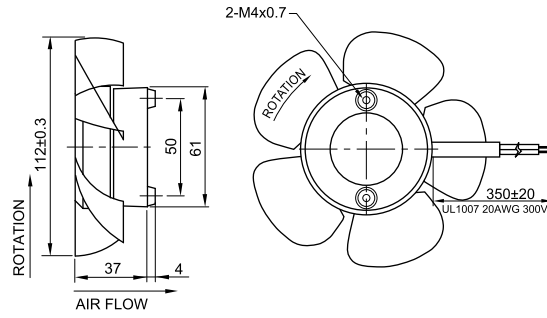

Ölçü (mm) : 112 x 41  
Impedance-Protected



MODEL	VOLTAJ (VAC)	FREKANS (Hz)	Güç (W)	AKIM (A)	HIZ (d/d)	m <sup>3</sup> /h	(CFM)	mmH <sub>2</sub> O	inchH <sub>2</sub> O	(dB)	FİYAT €
<b>UF12AE23</b>	230V	50	16	0.11	2700	144	85	4.0	0.15	38	<b>40</b>
		60	14	0.12	3000	162	95	4.8	0.18	42	

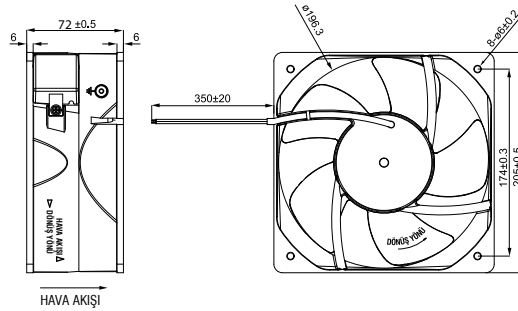

Ölçü (mm) : 205 x 205 x 72  
Thermally-Protected



MODEL	VOLTAJ (VAC)	FREKANS (Hz)	Güç (W)	AKIM (A)	HIZ (d/d)	m <sup>3</sup> /h	(CFM)	mmH <sub>2</sub> O	inchH <sub>2</sub> O	(dB)	FİYAT €
<b>UF20TC23-H</b>	230V	50	70	0.32	2800	1020	600	20.3	0.80	67	<b>85</b>
		60	98	0.45	3200	1158	680	19.8	0.77	71	

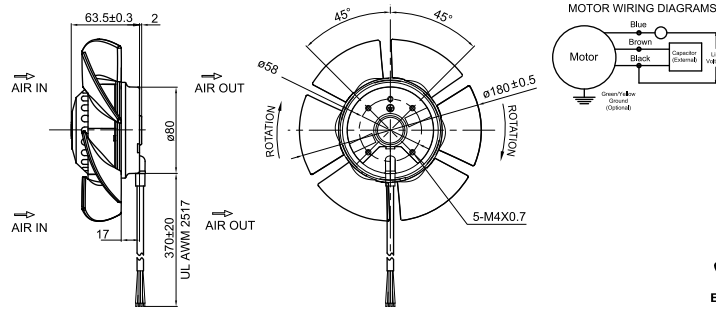
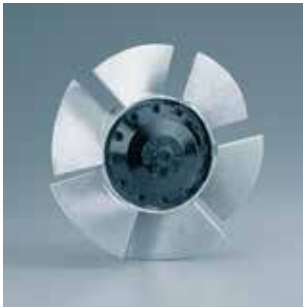

Ölçü (mm) : 180 x 63.5  
Thermally-Protected



MODEL	VOLTAJ (VAC)	FREKANS (Hz)	Güç (W)	AKIM (A)	HIZ (d/d)	m <sup>3</sup> /h	(CFM)	mmH <sub>2</sub> O	inchH <sub>2</sub> O	(dB)	FİYAT €
<b>UF180BAB23H</b>	230V	50	76	0.35	2750	570	335	7.50	0.65	62	<b>70</b>
		60	75	0.40	3100	660	388	10.0	0.78	65	

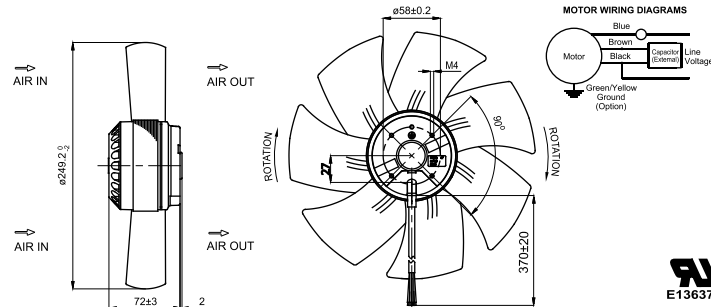

Ölçü (mm) : 250 x 72  
Thermally-Protected



MODEL	VOLTAJ (VAC)	FREKANS (Hz)	Güç (W)	AKIM (A)	HIZ (d/d)	m <sup>3</sup> /h	(CFM)	mmH <sub>2</sub> O	inchH <sub>2</sub> O	(dB)	FİYAT €
<b>UF250BMB23H1C2E</b>	230V	50	119	0.59	2550	1860	1090	16.5	0.65	68	<b>105</b>
		60	158	0.82	2700	1920	1130	20.0	0.78	70	

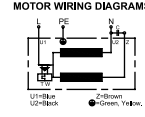
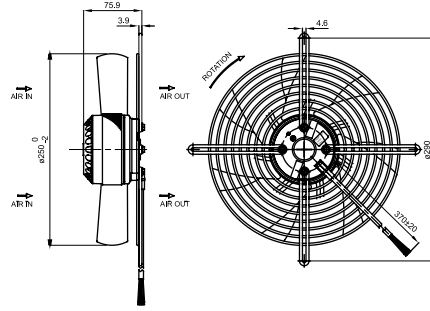

Ölçü (mm) : Ø290 x 75.9  
Thermally-Protected



MODEL	VOLTAJ (VAC)	FREKANS (Hz)	Güç (W)	AKIM (A)	HIZ (d/d)	m <sup>3</sup> /h	CFM	mmH <sub>2</sub> O	inchH <sub>2</sub> O	(dB)	FİYAT (€)
<b>UF250BMB23H1C2B</b>	230V	50	119	0.59	2550	1860	1090	20.0	0.78	68	<b>105</b>
		60	158	0.82	2700	1920	1130	16.5	0.65	70	

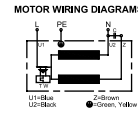
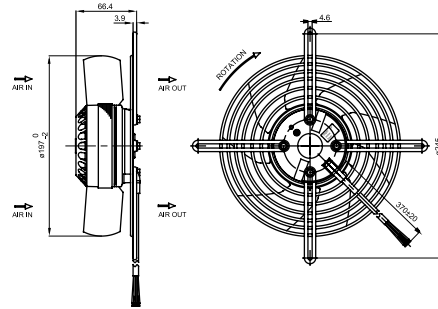

Ölçü (mm) : Ø245 x 66.5  
Thermally-Protected



MODEL	VOLTAJ (VAC)	FREKANS (Hz)	Güç (W)	AKIM (A)	HIZ (d/d)	m <sup>3</sup> /h	CFM	mmH <sub>2</sub> O	inchH <sub>2</sub> O	(dB)	FİYAT (€)
<b>UF200BMB23H1C2B</b>	230V	50	74	0.29	2550	900	530	17	0.67	59	<b>90</b>
		60	80	0.35	2800	1020	600	14	0.55	61	

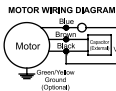
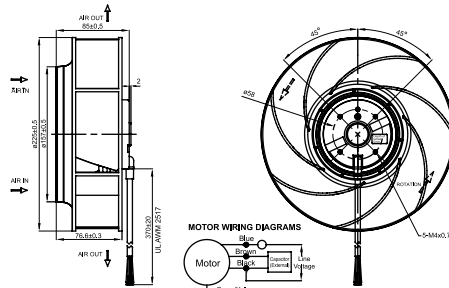

Ölçü (mm) : Ø225 x 85  
Thermally-Protected



MODEL	VOLTAJ (VAC)	FREKANS (Hz)	Güç (W)	AKIM (A)	HIZ (d/d)	m <sup>3</sup> /h	CFM	mmH <sub>2</sub> O	inchH <sub>2</sub> O	(dB)	FİYAT (€)
<b>UF225(85)APA23H1C2A</b>	230V	50	115	0.57	2700	1050	618	46	1.8	71	<b>90</b>
		60	135	0.60	3000	1152	680	64	2.5	75	
<b>UF225(99)APA23H1C2A</b>	230V	50	126	0.57	2650	1200	700	51	2.0	69	<b>100</b>
		60	157	1.14	2950	1310	770	66	2.6	71	

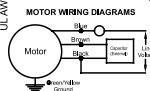
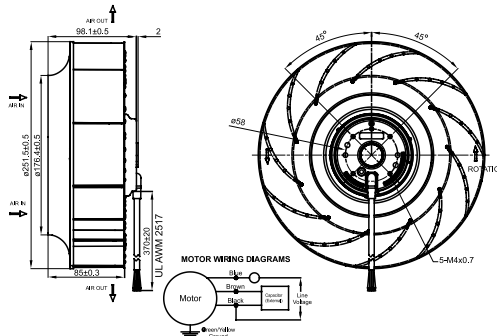

Ölçü (mm) : Ø251.5 x 98.1  
Thermally-Protected



MODEL	VOLTAJ (VAC)	FREKANS (Hz)	Güç (W)	AKIM (A)	HIZ (d/d)	m <sup>3</sup> /h	CFM	mmH <sub>2</sub> O	inchH <sub>2</sub> O	(dB)	FİYAT (€)
<b>UF250APA23H1C2A</b>	230V	50	170	0.77	2600	1320	770	56	2.2	75	<b>110</b>
		60	240	1.00	2700	1440	850	74	2.9	76	

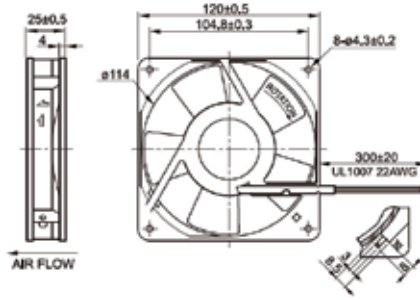

Ölçü (mm) : 120 x 120 x 25

Impedance-Protected



MODEL	VOLTAJ (VAC)	FREKANS (Hz)	Güç (W)	AKIM (A)	HIZ (d/d)	m <sup>3</sup> /h	CFM	mmH <sub>2</sub> O	inchH <sub>2</sub> O	(dB)	FİYAT (€)
<b>UF12BR11-BTH</b>	115V	50	14	0.15	2400	102	60	4.5	0.18	38	<b>25</b>
		60	11	0.12	2900	80	70	5.4	0.21	42	

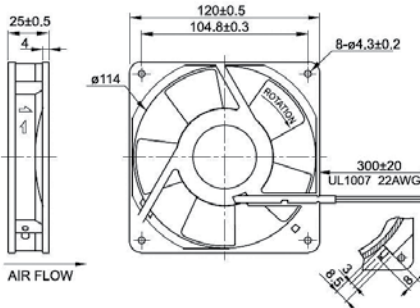

Ölçü (mm) : 120 x 120 x 25

Impedance-Protected



MODEL	VOLTAJ (VAC)	FREKANS (Hz)	Güç (W)	AKIM (A)	HIZ (d/d)	m <sup>3</sup> /h	CFM	mmH <sub>2</sub> O	inchH <sub>2</sub> O	(dB)	FİYAT (€)
<b>UF12B11-BTH</b>	115V	50	14	0.15	2400	108	62	4.7	0.19	38	<b>25</b>
		60	11	0.12	2900	126	75	4.7	0.19	42	

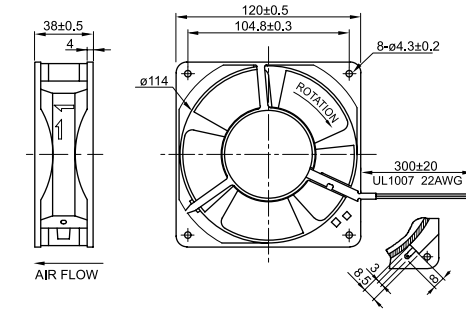

Ölçü (mm) : 120 x 120 x 38

Impedance-Protected



MODEL	VOLTAJ (VAC)	FREKANS (Hz)	Güç (W)	AKIM (A)	HIZ (d/d)	m <sup>3</sup> /h	CFM	mmH <sub>2</sub> O	inchH <sub>2</sub> O	(dB)	FİYAT (€)
<b>UF12AR11-BTH</b>	115V	50	13	0.20	2700	144	85	8.0	0.32	45	<b>25</b>
		60	11	0.19	3100	168	99	8.5	0.33	47	

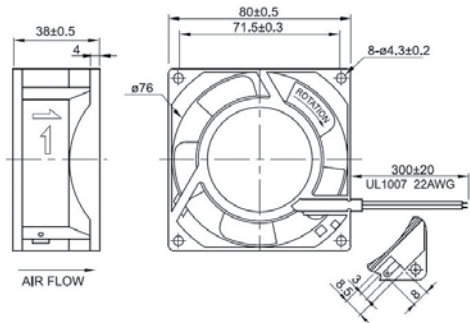

Ölçü (mm) : 80 x 80 x 38

Impedance-Protected



MODEL	VOLTAJ (VAC)	FREKANS (Hz)	Güç (W)	AKIM (A)	HIZ (d/d)	m <sup>3</sup> /h	CFM	mmH <sub>2</sub> O	inchH <sub>2</sub> O	(dB)	FİYAT (€)
<b>UF80A11-BTH</b>	115V	50	12	0.14	2500	41	24	3.6	0.14	32	<b>28</b>
		60	9	0.12	3000	50	30	5.3	0.21	36	



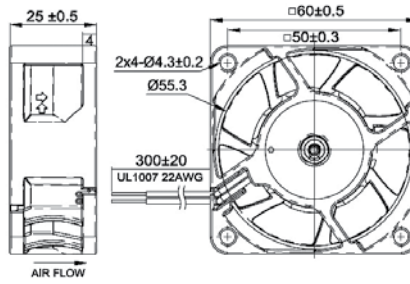

Ölçü (mm) : 60 x 60 x 25  
**Electronically-Protected**  
**IP68**



MODEL	VOLTAJ (VAC)	FREKANS (Hz)	Güç (W)	AKIM (A)	HIZ (d/d)	m <sup>3</sup> /h	CFM	mmH <sub>2</sub> O	inchH <sub>2</sub> O	(dB)	FİYAT (€)
<b>UFT60BBPB0AM1D4A</b>	115V	50	2.0	0.04	3850	32	19.1	4.3	0.17	31	<b>40</b>
	230V	60	2.4	0.025	3950	33	19.4	4.6	0.18		

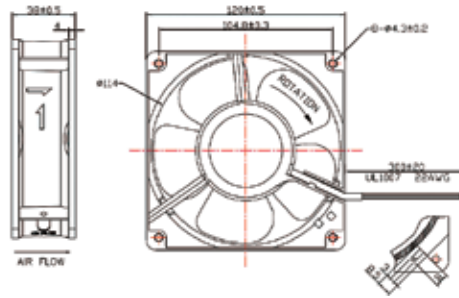

Ölçü (mm) : 120 x 120 x 38  
**Electronically-Protected**  
**IP68**



MODEL	VOLTAJ (VAC)	FREKANS (Hz)	Güç (W)	AKIM (A)	HIZ (d/d)	m <sup>3</sup> /h	CFM	mmH <sub>2</sub> O	inchH <sub>2</sub> O	(dB)	FİYAT (€)
<b>UFT12ABPB0AM1D4A</b>	115V	50	4.9	0.08	3200	180	106	8.6	0.34	43	<b>50</b>
	230V	60	5.2	0.06	3200	180	106	8.6	0.34		

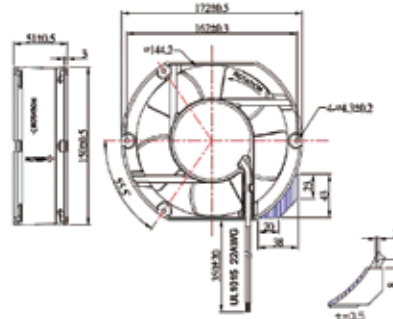

Ölçü (mm) : 172 x 150 x 51  
**Electronically-Protected**  
**IP68**



MODEL	VOLTAJ (VAC)	FREKANS (Hz)	Güç (W)	AKIM (A)	HIZ (d/d)	m <sup>3</sup> /h	CFM	mmH <sub>2</sub> O	inchH <sub>2</sub> O	(dB)	FİYAT (€)
<b>UFT15PBPB11M1D4A</b>	115V	50/60	15	0.23	3000	372	220	15.7	0.62	57	<b>80</b>
<b>UFT15PBPB23M1D4A</b>	230V	50/60	15	0.14	3000	372	220	15.7	0.62	57	<b>70</b>

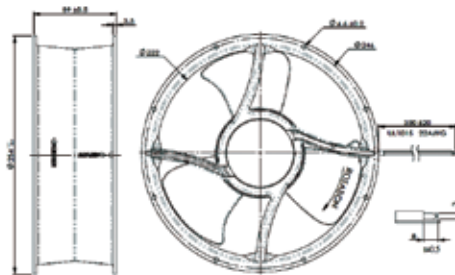

Ölçü (mm) : Ø254 x 89  
**Electronically-Protected**  
**IP68**



MODEL	VOLTAJ (VAC)	FREKANS (Hz)	Güç (W)	AKIM (A)	HIZ (d/d)	m <sup>3</sup> /h	CFM	mmH <sub>2</sub> O	inchH <sub>2</sub> O	(dB)	FİYAT (€)
<b>UFT25GPPB23M1D8A</b>	230V	50/60	88	0.80	3000	1542	910	32	1.26	73	<b>150</b>

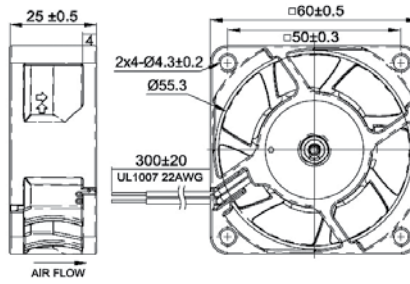

Ölçü (mm) : 60 x 60 x 25  
**Electronically-Protected**  
**IP68**



MODEL	VOLTAJ (VAC)	FREKANS (Hz)	Güç (W)	AKIM (A)	HIZ (d/d)	m <sup>3</sup> /h	CFM	mmH <sub>2</sub> O	inchH <sub>2</sub> O	(dB)	FİYAT (€)
<b>UFT60BBPB0AM1D4AN</b>	115V	50	2.0	0.04	3850	32	19.1	4.3	0.17	31	<b>50</b>
	230V	60	2.4	0.025	3950	33	19.4	4.6	0.18		

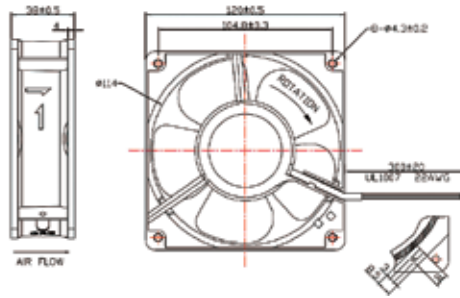

Ölçü (mm) : 120 x 120 x 38  
**Electronically-Protected**  
**IP68**



MODEL	VOLTAJ (VAC)	FREKANS (Hz)	Güç (W)	AKIM (A)	HIZ (d/d)	m <sup>3</sup> /h	CFM	mmH <sub>2</sub> O	inchH <sub>2</sub> O	(dB)	FİYAT (€)
<b>UFT12ABPB0AM1D4AN</b>	115V	50	4.9	0.08	3200	180	106	8.6	0.34	43	<b>60</b>
	230V	60	5.2	0.06	3200	180	106	8.6	0.34		

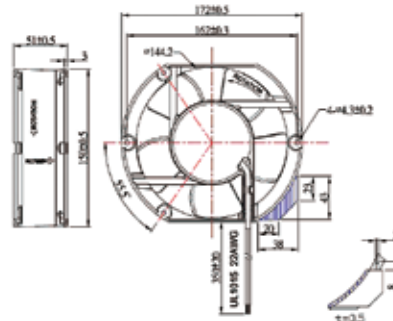

Ölçü (mm) : 172 x 150 x 51  
**Electronically-Protected**  
**IP68**



MODEL	VOLTAJ (VAC)	FREKANS (Hz)	Güç (W)	AKIM (A)	HIZ (d/d)	m <sup>3</sup> /h	CFM	mmH <sub>2</sub> O	inchH <sub>2</sub> O	(dB)	FİYAT (€)
<b>UFT15BPB11M1D4AN</b>	115V	50/60	15	0.23	3000	372	220	15.7	0.62	57	<b>90</b>
<b>UFT15BPB23M1D4AN</b>	230V	50/60	15	0.14	3000	372	220	15.7	0.62	57	<b>80</b>

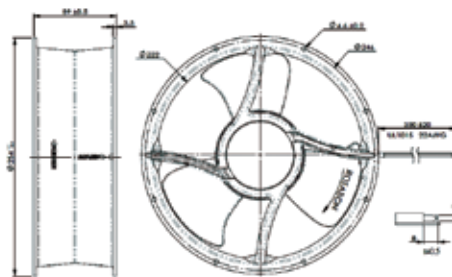

Ölçü (mm) : Ø254 x 89  
**Electronically-Protected**  
**IP68**



MODEL	VOLTAJ (VAC)	FREKANS (Hz)	Güç (W)	AKIM (A)	HIZ (d/d)	m <sup>3</sup> /h	CFM	mmH <sub>2</sub> O	inchH <sub>2</sub> O	(dB)	FİYAT (€)
<b>UFT25GPPB23M1D8AN</b>	230V	50/60	88	0.80	3000	1542	910	32	1.26	73	<b>180</b>

## FAN KORUMA TELİ METAL

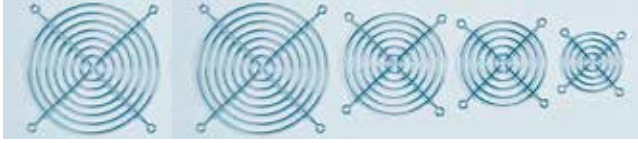

MG-150 MG-120 MG-92 MG-80 MG-60

MODEL	ÖLÇÜ	FİYAT €
MG-60	60x60 Fan İçin	2.00
MG-80	80x80 Fan İçin	2.00
MG-92	92x92 Fan İçin	2.00
MG-120	120x120 Fan İçin	2.00
MG-150	172x150 Fan İçin	2.40

## FAN KORUMA TELİ PLASTİK



PG-150 PG-120 PG-92 PG-80

MODEL	ÖLÇÜ	FİYAT €
PG-80	80x80 Fan İçin	1.50
PG-92	92x92 Fan İçin	1.60
PG-120	120x120 Fan İçin	2.00
PG-150	172x150 Fan İçin	2.40

## FAN FİLTRESİ PLASTİK



PFG-150 PFG-120 MSG-120 PFG-92 PFG-80

MODEL	ÖLÇÜ	FİYAT €
PFG-80	80x80 Fan İçin	2.00
PFG-92	92x92 Fan İçin	2.00
PFG-120	120x120 Fan İçin	2.40
MSG-120	120x120 Fan İçin	5.00
PFG-150	150x172 Fan İçin	3.00

## FİLTRE ÜNİTESİ



KOD	AÇIKLAMA	PAKET ADEDİ	FİYAT €
QFE-500	Fil 500 için	10	4.00
QFE-1000	Fil 1000 için	10	5.00
QFE-1500	Fil 1500 için	10	6.00
QFE-2000	Fil 2000 için	10	13.00
QFE-2500	Fil 2500 için	10	15.00
QFE-3000	Fil 3000 için	10	35.00

## FAN KORUMA TELİ METAL

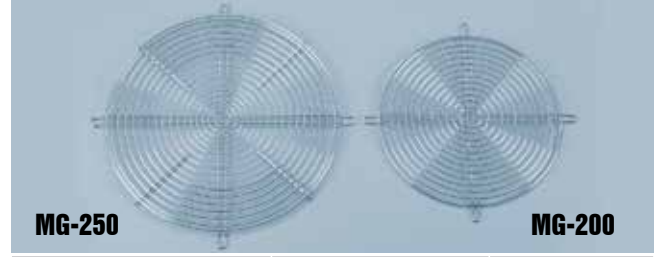

MG-250 MG-200

MODEL	ÖLÇÜ	FİYAT €
MG-200	225x225 Fan İçin	4.00
MG-220	190-220-225 Radyal	4.50
MG-250	280x280 Fan İçin	5.00

## FAN FİLTRESİ PLASTİK

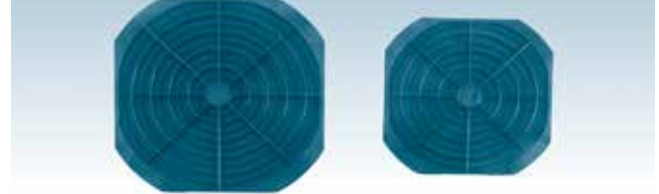

PFG-250P PFG-200B

MODEL	ÖLÇÜ	FİYAT €
PFG-200P	200x200 Fan İçin	5.00
PFG-250B	250x250 Fan İçin	6.00

## FAN KORUMA TELİ PLASTİK



PG-250B PG-200B

MODEL	ÖLÇÜ	FİYAT €
PG-200B	200x200 Fan İçin	4.00
PG-250B	250x250 Fan İçin	5.00

## FAN KABLOSU



MODEL	FİYAT - €
LA-10	2.00
LA-15	2.50
LA-25	3.50

**ebmpapst**

# ENDÜSTRİYEL FANLAR

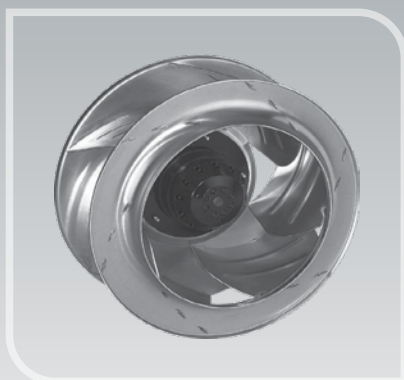
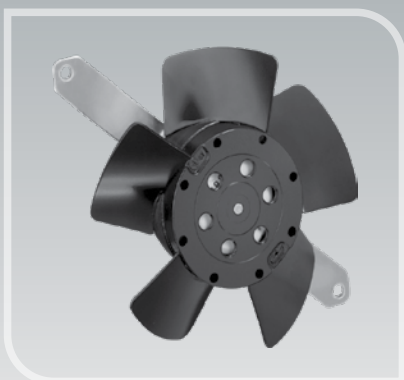
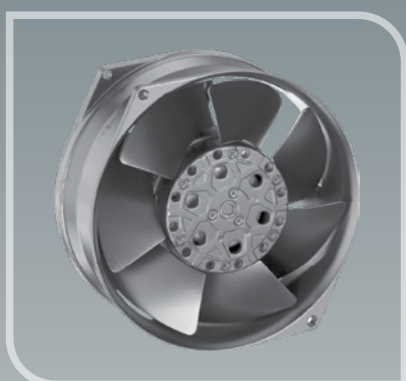



4650 Z



4656 TZ



W2S130



W2E200

## ebmpapst KOMPAKT FANLAR

Fan Tipi	Parakende Fiyat	Toptan Fiyat	Min. Sipariş Adedi	
8550 N	230 AC	35,60 €	27,40 €	24
3950	230 AC	50,10 €	40,50 €	27
4650 N	230 AC	22,50 €	17,40 €	18
4650 Z	230 AC	27,60 €	21,20 €	18
4656 N	230 AC	24,20 €	18,70 €	18
4656 Z	230 AC	35,60 €	27,40 €	18
4580 Z	230 AC (Düşük Sesli)	28,40 €	23,30 €	18
4600 Z	115 AC	35,60 €	27,40 €	18
ACI 4420 H	230 AC	39,20 €	31,80 €	18
5656 S	230 AC	83,10 €	68,40 €	10

Fan Tipi	Parakende Fiyat	Toptan Fiyat	Min. Sipariş Adedi	
412 F	12 DC	35,60 €	27,40 €	24
414 F	24 DC	35,60 €	27,40 €	24
512 F	12 DC	35,60 €	27,40 €	24
514 F	24 DC	35,60 €	27,40 €	24
612 F	12 DC	35,60 €	27,40 €	24
614 F	24 DC	35,60 €	27,40 €	24
3412 N	12 DC	44,00 €	34,70 €	27
3414 N	24 DC	44,00 €	34,70 €	27
8412 N	12 DC	35,60 €	27,40 €	36
8414 N	24 DC	35,60 €	27,40 €	36
4412 F	12 DC	35,60 €	27,40 €	26
4414 F	24 DC	31,80 €	24,40 €	26
4414 M	24 DC	35,60 €	27,40 €	18
7112 N	12 DC	109,50 €	88,50 €	12
7114 N	24 DC	95,80 €	76,50 €	12

Fan Tipi	Parakende Fiyat	Toptan Fiyat	Min. Sipariş Adedi	
W1G200-HH77-52	24 DC	195,00 €	161,00 €	10
W1G200-HH01-52	48 DC	196,30 €	160,60 €	10

Fan Tipi	Parakende Fiyat	Toptan Fiyat	Min. Sipariş Adedi	
W1G130-AA25-01	230 AC	107,90 €	88,70 €	10
W2S130-AA03-01	230 AC	66,00 €	53,50 €	10
W2S130-AA25-01	115 AC	153,30 €	123,00 €	10
W2E142-BB01-01	230 AC	85,00 €	68,50 €	10
W2E142-BB05-01	115 AC	152,30 €	123,70 €	10
W2E143-AA09-01	230 AC	120,80 €	87,20 €	10
W2E200-HK38-01	230 AC	89,20 €	72,30 €	10
W2E250-HL06-01	230 AC	107,50 €	86,80 €	10



R2E220



R4E355

## ebmpapst RADYAL FAN (GERİYE DÖNÜK SEYREKKANATLI)

Fan Tipi	Parakende Fiyat	Toptan Fiyat	Min. Sipariş Adedi
R2E133-BH66-05	95,00 €	45,90 €	24
R2E175-AR70-05	112,50 €	49,00 €	24
R2E190-RA26-05	98,10 €	40,50 €	24
R2E220-RB06-01	105,60 €	53,60 €	24
R2E225-RA92-09	128,30 €	69,60 €	12
R2E250-RA50-01	174,30 €	82,30 €	10
R2E250-RB06-01	246,00 €	99,90 €	10
R2E280-AE52-05	207,30 €	92,50 €	8
R2E280-RB01-01	314,10 €	187,00 €	8
R4E355-AF05-05	323,90 €	143,80 €	8
R4E400-AB23-05	309,20 €	150,90 €	8
R4E400-RO09-01	438,20 €	245,10 €	8
R4E450-AB09-06	451,40 €	285,60 €	4

\* Yukarıda belirtilen fiyatlara emiş ağız sıvaması **dahil değildir**.

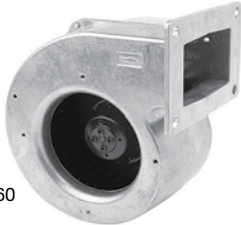

G2E160

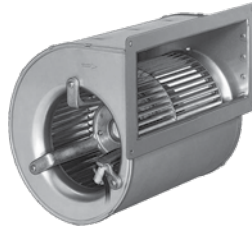

D2E146

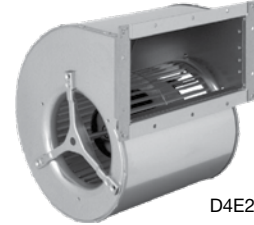

D4E200

## ebmpapst RADYAL FAN

### TEK EMİŞLİ RADYAL FANLAR (SALYANGOZ FAN)

Fan Tipi	Parakende Fiyat	Toptan Fiyat	Min. Sipariş Adedi
G2E085-AA01-01	62,00 €	52,500 €	16
G2E108-AG63-01	84,90€	70,50 €	24
G2E120-AR77-01	70,00 €	59,00 €	24
G2E140-AE77-01	86,80 €	69,90 €	18
G2E160-AY47-01	109,50 €	91,90 €	12
G2E180-EH03-01	247,00 €	208,60 €	10

### ÇİFT EMİŞLİ RADYAL FANLAR (SALYANGOZ FAN)

Fan Tipi	Parakende Fiyat	Toptan Fiyat	Min. Sipariş Adedi
D2E097-BI56-48	107,90 €	90,00 €	12
D2E133-AM47-23	116,50 €	98,50 €	12
D2E146-AP47-22	141,90 €	112,50 €	12
D2E160-AB01-21	292,50 €	247,00 €	4
D4E200-CA02-02	292,20 €	245,40 €	4
D4E225-CC01-02	299,00 €	250,70 €	4
D4E250-CA-01-01	392,50 €	317,70 €	4

### FAN COIL FANI

Fan Tipi	Parakende Fiyat	Toptan Fiyat	Min. Sipariş Adedi
D4E133-DH61-C6 (5 Hızlı)	96,80 €	80,10 €	12

# OPTİK SİNYALLER





Tip	Model	Açıklama	Teknik Özellikler	Sip. No.	Fiyat(€)	Sip. No.	Fiyat(€)
<b>Sinyal Lambası "Q" Serisi</b>				<b>Kırmızı Gövde</b>			
	<b>QDS</b>	LED Sabit / Flaşörlü Sinyal Lambası Boy 1 - IP66 turuncu, kırmızı, Şeffaf, mavi, yeşil, sarı	24 V AC/DC	874 16C 405	87,00		
			48 V AC/DC	874 16C 408	87,00		
			110-120 V AC	874 16C 310	104,00		
			230-240 V AC	874 16C 313	104,00		
	<b>QBS</b>	LED Çoklu Flaş Sinyal Lambası Boy 1 - IP66 turuncu, kırmızı, Şeffaf, mavi, yeşil, sarı	24-48 V AC/DC	874 17C 408	102,00		
			110-240 V AC	874 17C 313	120,00		
	<b>QFS</b>	Xenon Ampül, Çakar Lamba Boy 1 - IP66 Turuncu, kırmızı, sarı	24-48 V AC/DC, 5 J	874 56C 408	90,00		
			110-120 V AC, 5 J	874 56C 310	87,00		
			230-240 V AC, 5 J	874 56C 313	87,00		
	<b>QDM</b>	LED Sabit / Flaşörlü Sinyal Lambası Boy 2 - IP66 turuncu, kırmızı, Şeffaf, mavi, yeşil, sarı	24-48 V AC/DC	874 26C 408	150,00		
			110-240 V AC/DC	874 26C 413	150,00		
	<b>QBM</b>	LED Çoklu Flaş Sinyal Lambası Boy 2 - IP66 turuncu, kırmızı, Şeffaf, mavi, yeşil, sarı	24-48 V AC/DC	874 27C 408	168,00		
			110-240 V AC	874 27C 313	168,00		
	<b>QFM</b>	Xenon Ampül, Çakar Lamba Boy 2 - IP66 turuncu, kırmızı, sarı	24-48 V AC/DC, 10 J	874 66C 408	136,00		
			110-120 V AC, 10 J	874 66C 310	133,00		
			230-240 V AC, 10 J	874 66C 313	133,00		
	<b>QDL</b>	LED Sabit / Flaşörlü Sinyal Lambası Boy 3 - IP66 turuncu, kırmızı, sarı	24-48 V AC/DC	874 36C 408	334,00		
			110-240 V AC/DC	874 36C 413	357,00		
		LED Sabit / Flaşörlü Sinyal Lambası Boy 3 - IP66 Şeffaf, mavi, yeşil	24-48 V AC/DC	874 36C 408	368,00		
			110-240 V AC/DC	874 36C 413	397,00		
	<b>QBL</b>	LED Çoklu Çakar Sinyal Lambası Boy 3 - IP66 turuncu, kırmızı, sarı	24-48 V AC/DC	874 76C 408	344,00		
			110-240 V AC/DC	874 76C 413	357,00		
		LED Çoklu Çakar Sinyal Lambası Boy 3 - IP66 Şeffaf, mavi, yeşil	24-48 V AC/DC	874 76C 408	380,00		
			110-240 V AC/DC	874 76C 413	406,00		
	<b>QDX</b>	LED Sabit / Flaşörlü Sinyal Lambası Boy 4 - IP66 turuncu, kırmızı, sarı	24-48 V AC/DC	874 46C 408	617,00		
			110-240 V AC/DC	874 46C 413	617,00		
		LED Sabit / Flaşörlü Sinyal Lambası Boy 4 - IP66 Şeffaf, mavi, yeşil	24-48 V AC/DC	874 46C 408	686,00		
			110-240 V AC/DC	874 46C 413	708,00		
	<b>QBX</b>	LED Çoklu Çakar Sinyal Lambası Boy 4 - IP66 turuncu, kırmızı, sarı,	24-48 V AC/DC	874 86C 408	627,00		
			110-240 V AC/DC	874 86C 413	627,00		
		LED Çoklu Çakar Sinyal Lambası Boy 4 - IP66 Şeffaf, mavi, yeşil	24-48 V AC/DC	874 86C 408	696,00		
			110-240 V AC/DC	874 86C 413	719,00		
<b>Aksesuarlar "Q" Serisi</b>				<b>Kırmızı Gövde</b>			
	<b>AMK</b>	Montaj Kiti	Çok sesli "A" alıcısı ve "Q" uyarı ışığından oluşan kombinasyonlar için	874 010 900	10,00		
	<b>AG1</b>	Düz Conta - Boy 1		874 021 900	15,00		
	<b>AG2</b>	Düz Conta - Boy 2		874 022 900	17,00		
	<b>AG3</b>	Düz Conta - Boy 3		874 023 900	19,00		
	<b>AG4</b>	Düz Conta - Boy 4		874 024 900	21,00		
	<b>AB1</b>	Metal bağlantı kiti - Boy 1		874 031 900	30,00		
	<b>AB2</b>	Metal bağlantı kiti - Boy 2		874 032 900	34,00		
	<b>AB3</b>	Metal bağlantı kiti - Boy 3		874 033 900	61,00		
	<b>AB4</b>	Metal bağlantı kiti - Boy 4		874 034 900	69,00		
	<b>AKV</b>	Bez kablo M20x1,5		698 800 026	6,00		



Tip	Model	Açıklama	Teknik Özellikler	Sip. No.		Fiyat(€)
<b>R SERİSİ - Ø110mm</b>						
	<b>RDC</b>	Sabit yanar sinyal lambası - IP66 turuncu, kırmızı, Şeffaf, mavi, yeşil, sarı	12 V AC/DC	850 50C 004		133,00
			24 V AC/DC	850 50C 405		133,00
			48 V AC/DC	850 50C 408		133,00
			110-230 V AC/DC	850 50C 313		133,00
	<b>RDM</b>	LED çok fonksiyonlu sinyal lambası - IP66 turuncu, kırmızı, Şeffaf, mavi, yeşil, sarı Yanıp sönen, Çakar, Döner	12 V AC/DC	850 51C 004		156,00
			24 V AC/DC	850 51C 405		156,00
			48 V AC/DC	850 51C 408		156,00
			110-230 V AC/DC	850 51C 313		156,00
	<b>RDM-HP</b>	Yüksek performans LED çok fonksiyonlu sinyal lambası - IP66 turuncu, kırmızı, Şeffaf, mavi, yeşil, sarı	12 V AC/DC	850 52C 004		207,00
			24 V AC/DC	850 52C 405		207,00
			48 V AC/DC	850 52C 408		207,00
			110-230 V AC/DC	850 52C 313		207,00
	<b>RMM</b>	Çok Renkli - IP66 turuncu, kırmızı, Şeffaf, mavi, yeşil, sarı	12 V AC/DC			161,00
			24-48 V AC/DC	850 530 408		161,00
			110-230 V AC/DC	850 530 313		161,00
	<b>RCDM</b>	Kompakt Led çok fonksiyonlu - IP66 turuncu, kırmızı, Şeffaf, mavi, yeşil, sarı	12 V AC/DC	850 56C 004		110,00
			24-48 V AC/DC	850 56C 408		110,00
			110-230 V AC/DC	850 56C 313		110,00
	<b>RCMM</b>	Çok Renkli - IP66 turuncu, kırmızı, Şeffaf, mavi, yeşil, sarı	12 V AC/DC			110,00
			24-48 V AC/DC	850 570 408		110,00
			110-230 V AC/DC	850 570 313		110,00

Renkler : C : 1=Turuncu; 2=Kırmızı; 4=Şeffaf; 5=Mavi; 6=Yeşil; 7= Sarı



Tip	Model	Açıklama	Teknik Özellikler	Sip. No.		Fiyat(€)
<b>R SERİSİ - Ø110mm</b>						
	<b>RBA</b>	Çok sesli siren taban, 32 farklı ses maks. 95 dB ses basıncı, 3 ton harici olarak kontrol edilebilir tüm R serisi modeller için kullanılabilir.	24-48 V AC/DC	850 535 408		115,00
			110-230 V AC/DC	850 535 313		127,00
	<b>RBL</b>	Bağlantı tabanı		850 500 900		35,00
	<b>RBH</b>	Bağlantı tabanı		850 510 900		46,00
	<b>RBNPT</b>	NPT 1/2" boru montajı için evrensel taban		850 515 900		46,00
<b>R SERİSİ - Ø110mm Brackets</b>						
	<b>RWD</b>	Duvar tipi montaj tabanı		850 520 900		92,00
	<b>RWU</b>	Metal braket duvar tipi montaj tabanı		850 521 900		35,00
	<b>RWA</b>	Metal braket duvar tipi montaj tabanı		850 531 900		58,00
<b>R SERİSİ - Ø110mm Aksesuarlar</b>						
	<b>RG1</b>	Flat gasket for R-series bases to seal on smooth enclosures				12,00
	<b>RG2</b>	Flat gasket for vertical mounting of RWD design bracket				10,00
	<b>AKV</b>	Cable gland M20 for N/M/R-series, CT5, multitone sirens A and/or beacons Q				7,00
	<b>RKV</b>	Cable gland M16 for R series bases				9,00









# OPTİK SİNYALLER











Tip	Model	Açıklama	Teknik Özellikler	Sip. No.	Fiyat(€)	Sip. No.	Fiyat(€)
<b>Ø120mm</b>				<b>Gri Gövde</b>		<b>Siyah Gövde</b>	
	<b>WLG</b>	Sabit yanar ışık - IP65	250 V AC/DC'a kadar	822 10C 900	43,00	822 50C 900	43,00
	<b>BKG</b>	Yanıp sönen ışık - IP65	12-48 V AC/DC	832 10C 408	69,00	832 50C 408	69,00
			230/240 V AC	832 10C 313	73,00	832 50C 313	73,00
	<b>FLG</b>	Çakan flaş ışık - IP65	24 V AC/DC, ~5 J	842 14C 405	120,00	842 54C 405	120,00
			110/120 V AC, ~5 J	842 13C 310	110,00	842 53C 310	110,00
		230/240 V AC, ~5 J	842 13C 313	110,00	842 53C 313	110,00	
	<b>DLG</b>	LED Sabit Yanar Işık Turuncu, Sarı, Kırmızı IP65	24 V AC/DC	827 10C 405	113,00	827 50C 405	113,00
			48 V AC/DC	827 10C 408	113,00	827 50C 408	113,00
			110/120 V AC	827 10C 310	117,00	827 50C 310	117,00
			230/240 V AC	827 10C 313	117,00	827 50C 313	117,00
		LED Sabit Yanar Işık Mavi, Şeffaf, Yeşil IP65	24 V AC/DC	827 10C 405	189,00	827 50C 405	189,00
			48 V AC/DC	827 10C 408	189,00	827 50C 408	189,00
			110/120 V AC	827 10C 310	189,00	827 50C 310	189,00
			230/240 V AC	827 10C 313	189,00	827 50C 313	189,00
	<b>BLG</b>	LED Flaş Işık Turuncu, Sarı, Kırmızı IP65	24 V AC/DC	807 10C 405	122,00	807 50C 405	122,00
			48 V AC/DC	807 10C 408	122,00	807 50C 408	122,00
			110/120 V AC	807 10C 310	122,00	807 50C 310	122,00
			230/240 V AC	807 10C 313	122,00	807 50C 313	122,00
		LED Flaş Işık Mavi, Şeffaf, Yeşil IP65	24 V AC/DC	807 10C 405	214,00	807 50C 405	214,00
			48 V AC/DC	807 10C 408	214,00	807 50C 408	214,00
			110/120 V AC	807 10C 310	186,00	807 50C 310	186,00
			230/240 V AC	807 10C 313	186,00	807 50C 313	186,00
<b>WIG</b>	Bracket	Tüm "G" modelleri için				822 200 900	18,00
Renkler : C : 1=Turuncu; 2=Kırmızı; 4=Şeffaf; 5=Mavi; 6=Yeşil; 7= Sarı							
<b>Ledli Pano Aydınlatma Armatürü</b>				<b>Gri Gövde</b>			
	<b>ILL42</b>	LED Sabit Işık Kabin Armatürü IP44	24-48 V AC/DC	805 100 405	157,00		
		LED Sabit Işık Kabin Armatürü ON -OF Siviçli - IP44	24-48 V AC/DC	805 110 405	166,00		
		LED Sabit Işık Kabin Armatürü IP44	110/120 - 230/240 V AC/DC	805 100 413	165,00		
		LED Sabit Işık Kabin Armatürü ON -OF Siviçli - IP44	110/120 - 230/240 V AC	805 110 413	174,00		



Tip	Model	Açıklama	Teknik Özellikler	Sip. No.	Fiyat(€)	Sip. No.	Fiyat(€)
<b>Ø90mm</b>				<b>Taban Montajlı</b>		<b>Boru Montajlı</b>	
	<b>NES</b>	LED Sabit / Yanıp Sönen Işık Turuncu, kırmızı, sarı	12 - 24 V AC/DC	440 10C 405	187,00	440 30C 405	203,00
			24 - 48 V AC/DC	440 10C 408	187,00	440 30C 408	203,00
			110 - 240 V AC/DC	440 10C 413	199,00	440 30C 413	209,00
	LED Sabit / Yanıp Sönen Işık Şeffaf, mavi, yeşil	12 - 24 V AC/DC	440 10C 405	209,00	440 30C 405	221,00	
		24 - 48 V AC/DC	440 10C 408	209,00	440 30C 408	221,00	
		110 - 240 V AC/DC	440 10C 413	217,00	440 30C 413	227,00	
	<b>NFS</b>	LED Çift Çakan Flaş Işık Turuncu, kırmızı, sarı	24 - 48 V AC/DC	442 10C 408	178,00	442 30C 408	189,00
			110 V AC	442 10C 310	178,00	442 30C 310	189,00
			240 V AC	442 10C 313	178,00	442 30C 313	189,00
	LED Çift Çakan Flaş Işık Şeffaf, mavi, yeşil	24 - 48 V AC/DC	442 10C 408	196,00	442 30C 408	205,00	
		110 V AC	442 10C 310	196,00	442 30C 310	205,00	
		240 V AC	442 10C 313	196,00	442 30C 313	205,00	
	<b>NMS</b>	LED 3 Renkli Sabit / Yanıp Sönen Işık sarı, kırmızı, yeşil	24 V AC/DC	441 100 405	212,00	441 300 405	226,00
			48 V AC/DC	441 100 408	212,00	441 300 408	226,00
			110/120 V AC	441 100 310	224,00	441 300 310	236,00
			230/240 V AC	441 100 313	224,00	441 300 313	236,00
						<b>Direk Montaj Tabanı NPT 1/2"</b>	
	<b>NES</b>	LED Sabit / Yanıp Sönen Işık Turuncu, kırmızı, sarı	12 - 24 V AC/DC			440 40C 405	203,00
			24 - 48 V AC/DC			440 40C 408	203,00
			110 - 240 V AC/DC			440 40C 413	209,00
	LED Sabit / Yanıp Sönen Işık Şeffaf, mavi, yeşil	12 - 24 V AC/DC			440 40C 405	221,00	
		24 - 48 V AC/DC			440 40C 408	221,00	
		110 - 240 V AC/DC			440 40C 413	227,00	
	<b>NFS</b>	LED Çift Çakan Flaş Işık Turuncu, kırmızı, sarı	24 - 48 V AC/DC			442 40C 408	189,00
			110 V AC			442 40C 310	189,00
			240 V AC			442 40C 313	189,00
	LED Çift Çakan Flaş Işık Şeffaf, mavi, yeşil	24 - 48 V AC/DC			442 40C 408	205,00	
		110 V AC			442 40C 310	205,00	
		240 V AC			442 40C 313	205,00	
	<b>NMS</b>	LED 3 Renkli Sabit / Yanıp Sönen Işık sarı, kırmızı, yeşil	24 V AC/DC			441 400 405	226,00
			48 V AC/DC			441 400 408	226,00
			110/120 V AC			441 400 310	236,00
			230/240 V AC			441 400 313	236,00
<b>Ø90mm "Yüksek Performans"</b>				<b>Taban Montajlı</b>		<b>Boru Montajlı</b>	
	<b>NFS-HP</b>	"Yüksek Performans" LED çakar lamba Turuncu, kırmızı, Şeffaf	24 - 48 V AC/DC	442 15C 408	214,00	442 35C 408	217,00
			110 - 240 V AC/DC	442 15C 413	245,00	442 35C 413	248,00
			24 - 48 V AC/DC	442 15C 408	219,00	442 35C 408	221,00
	<b>NMS-HP</b>	"Yüksek Performans" LED 3 Renkli Sabit / Yanıp Sönen Işık Sarı, kırmızı, yeşil	110 - 240 V AC/DC	442 15C 413	245,00	442 35C 413	248,00
			24 - 48 V AC/DC	441 150 408	256,00	441 350 408	258,00
			110 - 240 V AC/DC	441 150 413	271,00	441 350 413	273,00

Renkler : C : 1=Turuncu; 2=Kırmızı; 4=Şeffaf; 5=Mavi; 6=Yeşil; 7=Sarı



Tip	Model	Açıklama	Teknik Özellikler	Sip. No.	Fiyat(€)	Sip. No.	Fiyat(€)
<b>Ø90mm "Yüksek Performans"</b>				<b>Taban Montajlı</b>		<b>Boru Montajlı</b>	
	<b>NFS-HP</b>	"Yüksek Performans" LED çakar lamba Turuncu, kırmızı, Şeffaf	24 - 48 V AC/DC			442 45C 408	217,00
			110 - 240 V AC/DC			442 45C 413	248,00
	<b>NMS-HP</b>	"Yüksek Performans" LED çakar lamba Mavi, yeşil	24 - 48 V AC/DC			442 45C 408	221,00
			110 - 240 V AC/DC			442 45C 413	248,00
	<b>NMS-HP</b>	"Yüksek Performans" LED 3 Renkli Sabit / Yanıp Sönen Işık Sarı, kırmızı, yeşil	24 - 48 V AC/DC			441 450 408	258,00
			110 - 240 V AC/DC			441 450 413	273,00
<b>Ø90mm Aksesuarları</b>				<b>Siyah Gövde</b>			
	<b>WMS</b>	Destek		817 200 900	21,00		
	<b>MBK</b>	Bağlama kiti	Boru yerleştirme için	819 201 900	15,00		
	<b>MQS</b>	Montaj düzlemi	UL için tip 4, 4X, 13	817 202 900	19,00		
	<b>MGS</b>	Manyetik destek		817 203 900	46,00		
	<b>AKV</b>	Bez kablo	M20x1,5	698 800 026	6,00		
	<b>MMR</b>	Plastik ayaklı alüminyum direk, siyah	50mm tüp uzunluğu	698 806 007	23,00		
			100mm tüp uzunluğu	698 806 008	28,00		
			250mm tüp uzunluğu	698 806 009	34,00		
			400mm tüp uzunluğu	698 806 010	46,00		
	<b>MSR</b>	Çinko ayaklı paslanmaz çelik di- rek, Elektrostatik toz boyalı, siyah	50mm tüp uzunluğu	698 806 021	30,00		
100mm tüp uzunluğu			698 806 022	33,00			
250mm tüp uzunluğu			698 806 023	42,00			
400mm tüp uzunluğu			698 806 024	52,00			
<b>Ø75mm - "P" Serisi Kablolulu Uyarı Işığı, Uzun Cam</b>				<b>Siyah Gövde</b>			
	<b>PCH</b>	LED Sabit / Yanıp Sönen Işık IP67 - Ø75 mm. Turuncu, Sarı, Kırmızı	24 V AC/DC	860 50C 405	88,00		
			110/120 V AC	860 50C 310	95,00		
			230/240 V AC	860 50C 313	95,00		
	<b>PCH</b>	LED Sabit / Yanıp Sönen Işık IP67 - Ø75 mm. Mavi, Şeffaf, Yeşil	24 V AC/DC	860 50C 405	101,00		
			110/120 V AC	860 50C 310	106,00		
			230/240 V AC	860 50C 313	106,00		
	<b>PFH</b>	LED Çift Çakar Lamba IP67 - Ø75 mm. Turuncu, Sarı, Kırmızı	24 V AC/DC	860 51C 405	91,00		
			110/120 V AC	860 51C 310	98,00		
			230/240 V AC	860 51C 313	98,00		
	<b>PFH</b>	LED Çift Çakar Lamba IP67 - Ø75 mm. Mavi, Şeffaf, Yeşil	24 V AC/DC	860 51C 405	98,00		
			110/120 V AC	860 51C 310	104,00		
			230/240 V AC	860 51C 313	104,00		
	<b>PMH</b>	LED Sabit Işık - 3 Renkli IP67 - Ø75 mm. Yeşil, Sarı, Kırmızı	24 V AC/DC	860 550 405	161,00		
			110/120 V AC	860 550 310	167,00		
			230/240 V AC	860 550 313	167,00		
	<b>PXH</b>	Xenon Çakar Lamba - 5J IP67 - Ø75 mm. Kırmızı, Turuncu	230/240 V AC	860 52C 313	83,00		
			10-100 V DC/20-70 V AC	860 52C 410	88,00		

Renkler : C : 1=Turuncu; 2=Kırmızı; 4=Şeffaf; 5=Mavi; 6=Yeşil; 7=Sarı









Tip	Model	Açıklama	Teknik Özellikler	Sip. No.	Fiyat(€)	Sip. No.	Fiyat(€)
<b>Ø75mm - "P" Serisi Kablolü Uyarı Işığı, Kısa Cam</b>				<b>Siyah Gövde</b>			
	<b>PCL</b>	LED Sabit / Yanıp Sönen Işık IP67 - Ø75 mm. Turuncu, Sarı, Kırmızı	24 V AC/DC	861 50C 405	69,00		
			110/120 V AC	861 50C 310	73,00		
			230/240 V AC	861 50C 313	73,00		
		LED Sabit / Yanıp Sönen Işık IP67 - Ø75 mm. Mavi, Şeffaf, Yeşil	24 V AC/DC	861 50C 405	79,00		
			110/120 V AC	861 50C 310	86,00		
			230/240 V AC	861 50C 313	86,00		
	<b>PFL</b>	LED Çift Çakar Lamba IP67 - Ø75 mm. Turuncu, Sarı, Kırmızı	24 V AC/DC	861 51C 405	80,00		
			110/120 V AC	861 51C 310	83,00		
			230/240 V AC	861 51C 313	81,00		
		LED Çift Çakar Lamba IP67 - Ø75 mm. Mavi, Şeffaf, Yeşil	24 V AC/DC	861 51C 405	87,00		
			110/120 V AC	861 51C 310	87,00		
			230/240 V AC	861 51C 313	87,00		
	<b>PXL</b>	Xenon Çakar Lamba - 2J IP67 - Ø75 mm. Kırmızı, Turuncu	230/240 V AC	861 52C 313	74,00		
			10-100 V DC/20-70 V AC	861 52C 410	78,00		
			Renkler : C : 1=Turuncu; 2=Kırmızı; 4=Şeffaf; 5=Mavi; 6=Yeşil; 7= Sarı				
<b>Ø75mm - "P" Serisi Aksesuarları</b>				<b>Siyah Gövde</b>			
	<b>PVW</b>	Dikey Montaj Dirseği		860 600 900	15,00		
	<b>PMR</b>	Boru montaj	100mm alüminyum tüp	860 702 900	34,00		
			250mm alüminyum tüp	860 703 900	36,00		
	<b>XWR</b>	direk montajlama tabanı için plastik ayaklı destek	XMR, YMR, ZMR, PMR için	900 600 900	21,00		
<b>Ø75mm - "T" Serisi Kablolü Uyarı Işığı</b>				<b>Siyah Gövde</b>			
	<b>TDC</b>	LED Sabit/Flaşlı Uyarı Işığı Turuncu, kırmızı, şeffaf, mavi, yeşil, sarı - IP66	24 V AC/DC	859 50C 405	73,00		
			110/120 V AC	859 50C 310	79,00		
			230/240 V AC	859 50C 313	79,00		
	<b>TDF</b>	LED Çoklu Çakan Uyarı Işığı Turuncu, kırmızı, şeffaf, mavi, yeşil, sarı - IP66	24 V AC/DC	859 51C 405	79,00		
			110/120 V AC	859 51C 310	83,00		
			230/240 V AC	859 51C 313	83,00		
	<b>TLL</b>	Sabit Uyarı Işığı Turuncu, kırmızı, şeffaf, mavi, yeşil, sarı - IP66	250 V AC/DC'a kadar	859 52C 900	21,00		
	<b>TMW</b>	Yatay mantajlama tabanı	Dahili montaj delikleri	859 500 900	19,00		
	<b>TMF</b>	Yatay mantajlama tabanı	Harici montaj delikleri	859 510 900	23,00		
	<b>TNL</b>	Yatay mantajlama tabanı	Yandan kablo girişli	859 515 900	49,00		
	<b>TMV</b>	Dikey mantajlama tabanı	Tek taraflı montaj için duvardan kablo girişli	859 520 900	28,00		
	<b>TMR</b>	Alüminyum tüp üzerinde direk ağzı ve plastik ayak	100mm	859 532 900	46,00		
			250mm	859 533 900	55,00		
	<b>TNW</b>	Direk tabanı	NPT1/2" direk montajı için	859 540 900	36,00		









Tip	Model	Açıklama	Teknik Özellikler	Sip. No.	Fiyat(€)	Sip. No.	Fiyat(€)
<b>Ø75mm - "T" Serisi Aksesuarları</b>				<b>Siyah Gövde</b>			
	<b>TDE</b>	Piezo Buzzer devamlı/kesikli ton, 100 dB - Ø75 - IP66	24 V AC/DC	859 560 405	80,00		
			110/120 V AC	859 560 310	82,00		
			230/240 V AC	859 560 313	82,00		
	<b>TDK</b>	Piezo Buzzer modül için başlık		859 560 000	10,00		
	<b>TVS</b>	Dikey montajlama için metal destek	TMW için, dikey Bez kablo M12x1,5	859 560 900	27,00		
	<b>XWR</b>	Direk montajı için plastik ayaklı destek	XMR, YMR, ZMR için	900 600 900	21,00		
	<b>PV1</b>	Koruyucu ağız	opsiyonel, Sadece taban ile bağlantılı TMW, TMF, TNL tipi	859 100 000	36,00		
<b>Ø60mm - "U" Serisi Uyarı Işığı</b>				<b>Siyah Gövde</b>			
	<b>UDC</b>	LED sabit/flashlı uyarı ışığı Turuncu, Kırmızı, şeffaf, mavi, yeşil, sarı Ø60 - IP66	24 V AC/DC	858 50C 405	55,00		
			110/120 V AC	858 50C 310	60,00		
			230/240 V AC	858 50C 313	60,00		
	<b>UDF</b>	LED çoklu çakan uyarı ışığı Turuncu, Kırmızı, şeffaf, mavi, yeşil, sarı Ø60 - IP66	24 V AC/DC	858 51C 405	60,00		
			110/120 V AC	858 51C 310	64,00		
			230/240 V AC	858 51C 313	64,00		
	<b>ULL</b>	Sabit uyarı ışığı Turuncu, Kırmızı, şeffaf, mavi, yeşil, sarı	250 V AC/DC'a kadar	858 52C 900	19,00		
	<b>UMW</b>	Yatay mantajlama tabanı	Dahili montaj delikleri	858 500 900	19,00		
	<b>UMF</b>	Yatay mantajlama tabanı	Harici montaj delikleri	858 510 900	23,00		
	<b>UNL</b>	Yatay mantajlama tabanı	Yandan kablo girişli	858 515 900	49,00		
	<b>UMV</b>	Dikey mantajlama tabanı	Tek taraflı montaj için duvardan kablo girişi	858 520 900	27,00		
	<b>UMR</b>	Alüminyum tüp üzerinde direk ağız ve plastik ayak	100mm	858 532 900	45,00		
			250mm	858 533 900	52,00		
	<b>UNW</b>	Direk tabanı	NPT1/2 için Direk montajı	858 540 900	34,00		
<b>Ø60mm - "U" Serisi Uyarı Işığı Aksesuarları</b>				<b>Siyah Gövde</b>			
	<b>UVS</b>	Dikey montajlama için metal destek	UMW için, dik montaj, bez kablo M12x1,5 kablo girişi aşağı-yukarı	858 550 900	25,00		
	<b>XWR</b>	Direk montajı için plastik ayaklı destek	XMR, YMR, ZMR için	900 600 900	21,00		
	<b>PV1</b>	Koruyucu ağız	opsiyonel, Sadece TMW, TMF, TNL tip tabanlarla bağlantılı	859 100 000	36,00		



Tip	Model	Açıklama	Teknik Özellikler	Sip. No.	Fiyat(€)	Sip. No.	Fiyat(€)
<b>Montaj kesim ölçüsü: Ø37mm - "T" Serisi - Yüksek Dayanıklı</b>				<b>Siyah Gövde</b>			
	<b>TDCP</b>	Düzlem Montaj LED Sabit/Flaşör Uyarı Işığı turuncu, kırmızı, şeffaf, mavi, yeşil, san Ø75 - IP66	24 V AC/DC	859 57C 405	83,00		
			110/120 V AC	859 57C 310	91,00		
			230/240 V AC	859 57C 313	91,00		
	<b>TDFP</b>	Düzlem Montaj LED Çoklu Çakan Uyarı Işığı turuncu, kırmızı, şeffaf, mavi, yeşil, san Ø75 - IP66	24 V AC/DC	859 58C 405	91,00		
			110/120 V AC	859 58C 310	95,00		
	<b>TLLP</b>	Düzlem Montaj Sabit Uyarı Işığı turuncu, kırmızı, şeffaf, mavi, yeşil, san Ø75 - IP66	250 V AC/DC'a kadar	859 59C 900	52,00		
<b>Montaj kesim ölçüsü: Ø37mm - "U" Serisi - Yüksek Dayanıklı</b>				<b>Siyah Gövde</b>			
	<b>UDCP</b>	Düzlem Montaj LED Sabit/Flaşör Uyarı Işığı turuncu, kırmızı, şeffaf, mavi, yeşil, san Ø60 - IP66	24 V AC/DC	858 57C 405	81,00		
			110/120 V AC	858 57C 310	89,00		
			230/240 V AC	858 57C 313	89,00		
	<b>UDFP</b>	Düzlem Montaj LED Çoklu Çakan Uyarı Işığı turuncu, kırmızı, şeffaf, mavi, yeşil, san Ø60 - IP66	24 V AC/DC	858 58C 405	89,00		
			110/120 V AC	858 58C 310	92,00		
	<b>ULLP</b>	Düzlem Montaj Sabit Uyarı Işığı Turuncu, kırmızı, şeffaf, mavi, yeşil, san Ø60 - IP66	250 V AC/DC'a kadar	858 59C 900	50,00		
<b>Montaj kesim ölçüsü: Ø22,5mm "I" Serisi</b>				<b>Gri Gövde</b>		<b>Siyah Gövde</b>	
	<b>IBL</b>	LED Sabit/Flaşör Uyarı Işığı turuncu, san, kırmızı Ø65 mm - IP65	12 V AC/DC	802 10C 404	67,00	802 50C 404	67,00
			24 V AC/DC	802 10C 405	67,00	802 50C 405	67,00
			110/120 V AC	802 10C 310	69,00	802 50C 310	69,00
			230/240 V AC	802 10C 313	69,00	802 50C 313	69,00
			12 V AC/DC	802 10C 404	101,00	802 50C 404	101,00
			24 V AC/DC	802 10C 405	101,00	802 50C 405	101,00
	<b>IBM</b>	LED Sabit/Flaşör Uyarı Işığı turuncu, san, kırmızı Ø45 mm - IP65	12 V AC/DC	801 10C 404	60,00	801 50C 404	60,00
			24 V AC/DC	801 10C 405	60,00	801 50C 405	60,00
			110/120 V AC	801 10C 310	61,00	801 50C 310	61,00
			230/240 V AC	801 10C 313	61,00	801 50C 313	61,00
			12 V AC/DC	801 10C 404	89,00	801 50C 404	89,00
			24 V AC/DC	801 10C 405	89,00	801 50C 405	89,00
	<b>IBM</b>	LED Sabit/Flaşör Uyarı Işığı mavi, şeffaf, yeşil Ø45 mm - IP65	110/120 V AC	801 10C 310	91,00	801 50C 310	91,00
			230/240 V AC	801 10C 313	91,00	801 50C 313	91,00

Renkler : C : 1=Turuncu; 2=Kırmızı; 4=Şeffaf; 5=Mavi; 6=Yeşil; 7=San



Tip	Model	Açıklama	Teknik Özellikler	Sip. No.	Fiyat(€)	Sip. No.	Fiyat(€)
Montaj kesim ölçüsü: Ø22,5mm "I" Serisi				Gri Gövde		Siyah Gövde	
	IBS	LED Sabit/Flaşlör Uyarı Işığı turuncu, sarı, kırmızı Ø30 mm - IP65	12 V AC/DC	800 10C 404	63,00	800 50C 404	63,00
			24 V AC/DC	800 10C 405	63,00	800 50C 405	63,00
			110/120 V AC	800 10C 310	64,00	800 50C 310	64,00
			230/240 V AC	800 10C 313	64,00	800 50C 313	64,00
		LED Sabit/Flaşlör Uyarı Işığı mavi, şeffaf, yeşil Ø30 mm - IP65	12 V AC/DC	800 10C 404	65,00	800 50C 404	65,00
			24 V AC/DC	800 10C 405	65,00	800 50C 405	65,00
			110/120 V AC	800 10C 310	79,00	800 50C 310	79,00
			230/240 V AC	800 10C 313	79,00	800 50C 313	79,00
	ICL	LED Çoklu Çakar Uyarı Işığı turuncu, sarı, kırmızı Ø65 mm - IP65	24 V AC/DC	802 12C 405	71,00	802 52C 405	71,00
			110/120 V AC	802 12C 310	74,00	802 52C 310	74,00
			230/240 V AC	802 12C 313	74,00	802 52C 313	74,00
	ICM	LED Çoklu Çakar Uyarı Işığı turuncu, sarı, kırmızı Ø45 mm - IP65	24 V AC/DC	801 12C 405	65,00	801 52C 405	65,00
			110/120 V AC	801 12C 310	67,00	801 52C 310	67,00
			230/240 V AC	801 12C 313	67,00	801 52C 313	67,00
	ISS	LED Çakar Uyarı Işığı turuncu, sarı, kırmızı Ø30 mm - IP65	12 V AC/DC	800 11C 404	64,00	800 51C 404	64,00
			24 V AC/DC	800 11C 405	64,00	800 51C 405	64,00
			110/120 V AC/DC	800 11C 310	67,00	800 51C 310	67,00
			230/240 V AC/DC	800 11C 313	67,00	800 51C 313	67,00
	ISM	LED Çakar Uyarı Işığı turuncu, kırmızı, şeffaf mavi, yeşil, sarı Ø45 mm - IP65	12-24 V AC/DC	801 11C 405	82,00	801 51C 405	82,00
			110/120 V AC	801 11C 310	79,00	801 51C 310	79,00
			230/240 V AC	801 11C 313	79,00	801 51C 313	79,00
	ISL	LED Çakar Uyarı Işığı turuncu, sarı, kırmızı Ø65 mm - IP65	12-24 V AC/DC	802 11C 405	76,00	802 51C 405	76,00
			110/120 V AC	802 11C 310	73,00	802 51C 310	73,00
			230/240 V AC	802 11C 313	73,00	802 51C 313	73,00











Renkler : C : 1=Turuncu; 2=Kırmızı; 4=Şeffaf; 5=Mavi; 6=Yeşil; 7= Sarı



# OPTIK SINYALLER





Tip	Model	Açıklama	Teknik Özellikler	Sip. No.	Fiyat(€)	Sip. No.	Fiyat(€)
<b>Montaj kesim ölçüsü: Ø22,5mm "I" Serisi</b>				<b>Gri Gövde</b>		<b>Siyah Gövde</b>	
	<b>IDL</b>	LED Sabit Yanan Işık 2 Renkli: <b>kırmızı, yeşil</b> Ø65 mm - IP65	24 V AC/DC	802 226 405	71,00	802 626 405	71,00
			110/120 V AC	802 226 310	73,00	802 626 310	73,00
			230/240 V AC	802 226 313	73,00	802 626 313	73,00
	<b>IDM</b>	LED Sabit Yanan Işık 2 Renkli: <b>kırmızı, yeşil</b> Ø45 mm - IP65	24 V AC/DC	801 226 405	64,00	801 626 405	64,00
			110/120 V AC	801 226 310	65,00	801 626 310	65,00
			230/240 V AC	801 226 313	65,00	801 626 313	65,00
	<b>IDS</b>	LED Sabit Yanan Işık 2 Renkli: <b>kırmızı, yeşil</b> Ø65 mm - IP65	24 V AC/DC	800 226 405	61,00	800 626 405	61,00
	<b>ITL</b>	LED Sabit Yanan Işık 2 Renkli: <b>kırmızı, yeşil</b> Ø65 mm - IP65	24 V AC/DC	802 326 405	73,00	802 726 405	73,00
			110/120 V AC	802 326 310	74,00	802 726 310	74,00
			230/240 V AC	802 326 313	74,00	802 726 313	74,00
	<b>ITM</b>	LED Sabit Yanan Işık 2 Renkli: <b>kırmızı, yeşil</b> Ø45 mm - IP65	24 V AC/DC	801 326 405	65,00	801 726 405	65,00
			110/120 V AC	801 326 310	65,00	801 726 310	65,00
			230/240 V AC	801 326 313	65,00	801 726 313	65,00
	<b>ITS</b>	LED Sabit Yanan Işık 2 Renkli: <b>kırmızı, yeşil</b> Ø30 mm - IP65	24 V AC/DC	800 326 405	64,00	800 726 405	64,00
	<b>IML</b>	LED Sabit Yanan Işık 3 Renkli: <b>sağ, kırmızı, yeşil</b> Ø65 mm - IP67	24 V AC/DC	802 150 405	89,00	802 550 405	89,00
			110/120 V AC	802 150 310	95,00	802 550 310	95,00
			230/240 V AC	802 150 313	95,00	802 550 313	95,00
	<b>IMM</b>	LED Sabit Yanan Işık 3 Renkli: <b>sağ, kırmızı, yeşil</b> Ø45 mm - IP67	24 V AC/DC	801 150 405	82,00	801 550 405	82,00
	<b>ADM30</b>	Adaptör M30.5mm				812 500 900	12,00
	<b>AR1</b>	Anti rotation washer	5 pcs. paket			812 300 900	11,00
	<b>WZ30</b>	Rakor sıkma aparatı M2230mm				812 400 900	10,00



Tip	Model	Açıklama	Teknik Özellikler	Sip. No.	Fiyat(€)	Sip. No.	Fiyat(€)
<b>Z Serisi Çakan Flaşörlü</b>				<b>Gri Gövde</b>			
	<b>BZG</b>	Çakan flaş ışık	24 V DC, <b>turuncu</b>	741 041 005	267,00		
			24 V DC, <b>kırmızı</b>	741 042 005	267,00		
			24 V DC, <b>sağ</b>	741 047 005	267,00		
			230/240 V AC, <b>turuncu</b>	741 031 313	230,00		
			230/240 V AC, <b>kırmızı</b>	741 032 313	230,00		
			230/240 V AC, <b>sağ</b>	741 037 313	230,00		
<b>Ledli Flaşör</b>				<b>Kırmızı Gövde</b>		<b>Beyaz Gövde</b>	
	<b>BC1</b>	Ledli Flaşör	24 V DC	C112 62C 005	64,00	C112 22C 005	64,00
			Cam rengi C: 1, 2				
<b>X B2 Serisi</b>				<b>Kırmızı Gövde</b>		<b>Beyaz Gövde</b>	
	<b>XB2</b>	Zenon Ampulu	12 V DC, 2 J			D118 52C 004	35,00
			24 V DC, 2 J			D118 52C 005	35,00
			24 V AC, 2 J			D118 52C 305	35,00
			230 V AC, 2 J			D118 52C 313	35,00
			Lens rengi C: 1, 2, 4, 5, 6				
<b>"K" serileri Q60mm</b>						<b>Siyah Gövde</b>	
	<b>WLK</b>	Sabit yanan ışık	0-250 V AC	820 00C 900	10,00		
	<b>BHW</b>	Düz Tabana Montaj				820 520 900	14,00
	<b>BVW</b>	Duvar Bağlantılı Ayak				820 530 900	17,00

	<b>FLK</b>	Xzenon ampullü	12-24 V AC/DC, <b>turuncu</b>	840 001 405			64,00
			12-24 V AC/DC, <b>kırmızı</b>	840 002 405			64,00
			12-24 V AC/DC, <b>sağ</b>	840 007 405			64,00
			230 V AC, <b>turuncu</b>	840 001 313			56,00
			230 V AC, <b>kırmızı</b>	840 002 313			56,00
			230 V AC, <b>sağ</b>	840 007 313			56,00
	<b>BHF</b>	Taban bağlantı ayak				840 501 900	7,00
	<b>BVF</b>	Duvar bağlantı ayak				840 502 900	12,00

Renkler : C : 1=Turuncu; 2=Kırmızı; 4=Şeffaf; 5=Mavi; 6=Yeşil; 7=Sağ



# Auer Signal

## SİNYAL KULELERİ SIGNAL TOWERS



Türkiye Distribütörü





| [www.esen.com.tr](http://www.esen.com.tr)









# İKAZ KULELERİ





Tip	Model	Açıklama	Teknik Özellikler	Sip. No.	Fiyat(€)
		<p><b>Önceden yapılandırılmış ECOMODUL70</b>  <b>Sinyal Kuleleri 24 V AC/DC</b>  <b>LED sabit ışık modülleri XDC</b>  <b>100mm alu-pole üzerinde plastik ayaklı direk montaj tabanı</b></p>			
	EC070- Q01	XDC LED sabit ışık kırmızı XDC LED sabit ışık turuncu XDC LED sabit ışık yeşil 100mm alu-tüp/plastik ayaklı XMR direk tabanı		EC070- Q01	152,00
	EC070- Q02	XDC LED sabit ışık kırmızı XDC LED Sabit ışık yeşil 100mm alu-tube/plastik ayaklı XMR direk tabanı		EC070- Q02	112,00
	EC070- Q05	XDC LED sabit ışık kırmızı XDC LED sabit ışık turuncu XDC LED sabit ışık yeşil XDC LED sabit ışık mavi 100mm alu-tube/plastik ayaklı XMR direk tabanı		EC070- Q05	196,00
	EC070- Q31	XDE piezo buzzer DEVAMI ya da KESİKLİ ton XDC LED sabit ışık kırmızı XDC LED sabit ışık turuncu XDC LED sabit ışık yeşil 100mm alu-tube/plastik ayaklı XMR direk tabanı		EC070- Q31	196,00
		<p><b>Önceden yapılandırılmış ECOMODUL70</b>  <b>Sinyal Kuleleri 230/240 V AC</b>  <b>LED sabit ışık modülleri XDC</b>  <b>100mm alu-pole üzerinde plastik ayaklı direk montaj tabanı</b></p>			
	EC070- Q81	XDE piezo buzzer SÜREKLİ ya da KESİK ton XDC LED sabit ışık kırmızı XDC LED sabit ışık turuncu XDC LED sabit ışık yeşil 100mm alu-tube/plastik ayaklı XMR direk tabanı		EC070- Q81	205,00



Tip	Model	Açıklama	Teknik Özellikler	Sip. No.	Fiyat(€)
<b>Birbirinden ayrı olarak ayarlanabilir ECOmodul70 Sinyal kuleleri</b>					
	XLL	Sabit yanar lamba Turuncu, Sarı, Kırmızı, Yeşil Mavi, Şeffaf - IP65	up to 250 V AC/DC	900 00C 900	17,00
	XDC	LED'li sabit yanar lamba Turuncu, Sarı, Kırmızı, Yeşil IP65	24 V AC/DC	900 01C 405	41,00
			110/120 V AC	900 01C 310	43,00
			230/240 V AC	900 01C 313	43,00
		LED'li sabit yanar lamba Mavi, Şeffaf IP65	24 V AC/DC	900 01C 405	44,00
			110/120 V AC	900 01C 310	49,00
			230/240 V AC	900 01C 313	49,00
	XDA	LED'li flaşörlü lamba Turuncu, Sarı, Kırmızı, Yeşil IP65	24 V AC/DC	900 02C 405	43,00
			110/120 V AC	900 02C 310	46,00
			230/240 V AC	900 02C 313	46,00
		LED'li flaşörlü lamba Mavi, Şeffaf IP65	24 V AC/DC	900 02C 405	49,00
			110/120 V AC	900 02C 310	50,00
			230/240 V AC	900 02C 313	50,00
	XDF	LED'li çakar lamba Turuncu, Sarı, Kırmızı, Yeşil IP65	24 V AC/DC	900 03C 405	44,00
			110/120 V AC	900 03C 310	49,00
			230/240 V AC	900 03C 313	49,00
		LED'li çakar lamba Mavi, Şeffaf IP65	24 V AC/DC	900 03C 405	50,00
			110/120 V AC	900 03C 310	52,00
			230/240 V AC	900 03C 313	52,00
<b>"Yüksek Performans" – modelleri</b>					
	XDC-HP	LED'li sabit yanar lamba "yüksek performans" Turuncu, Sarı, Kırmızı, Yeşil IP65	24 V AC/DC	900 05C 405	109,00
		LED'li sabit yanar lamba "yüksek performans" Mavi, Şeffaf IP65	24 V AC/DC	900 05C 405	141,00
	XDF-HP	LED'li çakar lamba "yüksek performans" Turuncu, Sarı, Kırmızı, Yeşil IP65	24 V AC/DC	900 06C 405	117,00
		LED'li çakar lamba "yüksek performans" Mavi, Şeffaf IP65	24 V AC/DC	900 06C 405	145,00
	XFF-HP	LED'li çoklu çakar lamba "yüksek performans" Turuncu, Sarı, Kırmızı, Yeşil IP65	24 V AC/DC	900 07C 405	120,00
		LED'li çoklu çakar lamba "yüksek performans" Mavi, Şeffaf IP65	24 V AC/DC	900 07C 405	150,00

900 07C 405

Renkler : C : 1=Turuncu; 2=Kırmızı; 4=Şeffaf; 5=Mavi; 6=Yeşil; 7= Sarı



Tip	Model	Açıklama	Teknik Özellikler	Sip. No.	Fiyat(€)
	<b>eco 70</b>			<b>Siyah Gövde</b>	
	<b>XDE</b>	Piezo Buzzer Sürekli veya Kesik Kesik Ses 100 dB	24 V AC/DC	900 500 405	44,00
			110/120 V AC	900 500 310	46,00
			230/240 V AC	900 500 313	46,00
	<b>XDZ</b>	Piezo Buzzer Sürekli ve Kesik Kesik Ses Dıştan Ses Ayarlı 100 dB	24 V AC/DC	900 510 405	50,00
			110/120 V AC	900 510 310	52,00
			230/240 V AC	900 510 313	52,00
	<b>XDM</b>	Çok Sesli Siren 8 Farklı Ses Seçeneği Volume Ayarlı 100dB	24 V AC/DC	900 520 405	72,00
			110/120 V AC	900 520 310	78,00
			230/240 V AC	900 520 313	78,00
	<b>XMW</b>	Yatay Montaj Bağlantı Tabanı	içten montaj delikli	900 570 900	22,00
	<b>XMS</b>	Yatay Montaj Bağlantı Tabanı	hazır sabitleme vidalı	900 571 900	26,00
	<b>XMf</b>	Yatay Montaj Bağlantı Tabanı	dıştan montaj delikli	900 572 900	26,00
	<b>XMV</b>	Dikey Montaj Bağlantı Tabanı	tek taraflı	900 573 900	32,00
	<b>XZV</b>	Dikey Montaj Bağlantı Tabanı	çift taraflı	900 574 900	41,00
	<b>XMR</b>	Plastik Ayaklı Alüminyum Borulu Montaj Bağlantı Tabanı	100 mm	900 582 900	32,00
			250 mm	900 583 900	37,00
			400 mm	900 584 900	46,00
	<b>XNW</b>	Direk montaj tabanı	NPT 1/2" tel için	900 570 950	34,00
	<b>XWR</b>	Plastik Ayaklı Duvar Montaj Dirseği	XMR, YMR, ZMR için	900 600 900	21,00
	<b>XSW</b>	Civatalı Alüminyum Borulu Yatay Montaj Bağlantı Tabanı	100 mm	900 592 900	53,00
			250 mm	900 593 900	58,00
			400 mm	900 594 900	71,00
	<b>XMU</b>	Harici Boru Montajı İçin Taban	Ø 25mm dış borulara uyumludur	900 585 900	30,00









Tip	Model	Açıklama	Teknik Özellikler	Sip. No.	Sip. No.	Fiyat(€)
		<b>eco 70</b>		<b>Siyah Gövde</b>		
	<b>XSS</b>	Dikey Montaj Bağlantı Tabanı	XSW, YSW, ZSW için	900 700 900		21,00
	<b>XFR</b>	Hızlı Bağlamak için Ayak Adaptörlü Alüminyum Borulu Montaj Tabanı	100 mm	900 562 900		87,00
			250 mm	900 563 900		90,00
			400 mm	900 564 900		104,00
	<b>XEP</b>	Taban Uzantısı100mm Boy	bütün tabanlara uygun	900 800 900		12,00
		<b>AKSESUARLAR</b>	<b>NET FİYAT</b>			0,00
	<b>XIB</b>	Gösterge Paneli	bütün tabanlara uygun	900 850 900		41,00
	<b>LWW</b>	Ampul Değişirme Aparatı	opsiyonlu	890 900 900		10,00
		<b>XMR direk montaj tabanları için malzemeler</b>		<b>Siyah Gövde</b>		0,00
	<b>BDW</b>	Yatay montaj için	Yatay montaj için	841 10T 900	841 50T 900	18,00
	<b>BDV</b>	Dikey montaj için	Dikey montaj için	841 11T 900	841 51T 900	27,00
	<b>BDM</b>	Mıknatıslı bağlantı kutusu	Manyetik montajlama için	841 12T 900	841 52T 900	52,00
	<b>SKE</b>	Vidalama seti	ECOmodul70/60/40 ve modulCOMPACT70 Sinyal kuleleri ile direk bağlantı için kullanılır	841 000 900		9,00

Bağlantı Kodları T : 1 = M20; 2 = NPT 1/2"



Tip	Model	Açıklama	Teknik Özellikler	Sip. No.	Fiyat(€)
		<p><b>Önceden yapılandırılmış ECOMODUL60</b>  <b>Sinyal kuleleri 24 V AC/DC</b>  <b>LED sabit ışık modülleri YDC</b>  <b>100mm alu-pole üzerinde plastik ayaklı direk montaj tabanı</b></p>			
	EC060-Q01	<p>YDC LED sabit ışık <b>kırmızı</b>  YDC LED sabit ışık <b>turuncu</b>  YDC LED sabit ışık <b>yeşil</b>  100mm alu-tube/plastik ayaklı YMR direk tabanı</p>		EC060-Q01	135,00
	EC060-Q02	<p>YDC LED sabit ışık <b>kırmızı</b>  YDC LED sabit ışık <b>yeşil</b>  100mm alu-tube/plastik ayaklı YMR direk tabanı</p>		EC060-Q02	101,00
	EC060-Q05	<p>YDC LED sabit ışık <b>kırmızı</b>  YDC LED sabit ışık <b>turuncu</b>  YDC LED sabit ışık <b>yeşil</b>  YDC LED sabit ışık <b>mavi</b>  100mm alu-tube/plastik ayaklı YMR direk tabanı</p>		EC060-Q05	172,00
	EC060-Q31	<p>YDE piezo buzzer <b>SÜREKLİ</b> ya da <b>KESİKLİ</b> ton  YDC LED sabit ışık <b>kırmızı</b>  YDC LED sabit ışık <b>turuncu</b>  YDC LED sabit ışık <b>yeşil</b>  100mm alu-tube/plastik ayaklı YMR direk tabanı</p>		EC060-Q31	178,00
		<p><b>Önceden yapılandırılmış ECOMODUL60</b>  <b>Sinyal Kuleleri 230/240 V AC</b>  <b>LED sabit ışık modülleri YDC</b>  <b>100mm alu-pole üzerinde plastik ayaklı direk montaj tabanı</b></p>			
	EC060-Q81	<p>YDE piezo buzzer <b>SÜREKLİ</b> ya da <b>KESİKLİ</b> ton  YDC LED sabit ışık <b>kırmızı</b>  YDC LED sabit ışık <b>turuncu</b>  YDC LED sabit ışık <b>yeşil</b>  100mm alu-tube/plastik ayaklı YMR direk tabanı</p>		EC060-Q81	186,00











Tip	Model	Açıklama	Teknik Özellikler	Sip. No.	Sip. No.	Fiyat(€)
<b>Bağımsız şekilde yapılandırılabilir EComodul60 Sinyal Kuleleri</b>						
	YLL	Sabit Yanan Lamba Turuncu, Kırmızı, Şeffaf, Yeşil Mavi, Sarı - IP65	250 V AC/DC'a kadar	901 00C 900		15,00
	YDC	LED'li Sabit Yanan Lamba Turuncu, Sarı, Kırmızı, Yeşil IP65	24 V AC/DC	901 01C 405		35,00
			110/120 V AC	901 01C 310		37,00
			230/240 V AC	901 01C 313		37,00
		LED'li Sabit Yanan Lamba Mavi, Şeffaf IP65	24 V AC/DC	901 01C 405		37,00
			110/120 V AC	901 01C 310		40,00
			230/240 V AC	901 01C 313		40,00
	YDA	LED'li Flaşörlü Lamba Turuncu, Sarı, Kırmızı, Yeşil IP65	24 V AC/DC	901 02C 405		37,00
			110/120 V AC	901 02C 310		40,00
			230/240 V AC	901 02C 313		40,00
		LED'li Flaşörlü Lamba Mavi, Şeffaf IP65	24 V AC/DC	901 02C 405		40,00
			110/120 V AC	901 02C 310		41,00
			230/240 V AC	901 02C 313		41,00
	YDF	LED'li Çakar Lamba Turuncu, Sarı, Kırmızı, Yeşil IP65	24 V AC/DC	901 03C 405		40,00
			110/120 V AC	901 03C 310		41,00
			230/240 V AC	901 03C 313		41,00
		LED'li Çakar Lamba Mavi, Şeffaf IP65	24 V AC/DC	901 03C 405		41,00
			110/120 V AC	901 03C 310		43,00
			230/240 V AC	901 03C 313		43,00
<b>"Yüksek performans" modelleri</b>						
	YDC-HP	LED'li Sabit Yanan Lamba""Yüksek Performans"" Turuncu, Sarı, Kırmızı, Yeşil IP65	24 V AC/DC	901 05C 405		90,00
		LED'li Sabit Yanan Lamba""Yüksek Performans"" Mavi, Şeffaf IP65	24 V AC/DC	901 05C 405		120,00
	YFF-HP	LED'li Çoklu Çakar Lamba""Yüksek Performans"" Turuncu, Sarı, Kırmızı, Yeşil IP65	24 V AC/DC	901 07C 405		98,00
		LED'li Çoklu Çakar Lamba""Yüksek Performans"" Mavi, Şeffaf IP65	24 V AC/DC	901 07C 405		127,00



Tip	Model	Açıklama	Teknik Özellikler	Sip. No.	Fiyat(€)
	eco 60			Siyah Gövde	
	YDE	Piezo BuzzerSürekli veya Kesik Kesik Ses100 dB	24 V AC/DC	901 500 405	43,00
			110/120 V AC	901 500 310	44,00
			230/240 V AC	901 500 313	44,00
	YMW	Yatay Bağlantı Tabanı	Dahili montaj delikleri	901 570 900	21,00
	YMS	Yatay Bağlantı Tabanı	Önceden montajlanmış sabitleme vidaları	901 571 900	26,00
	YMF	Yatay Bağlantı Tabanı	Harici montaj delikleri	901 572 900	26,00
	YMC	Yatay montajlama için 5 direk entegreli M12 bağlayıcı taban	Harici montaj delikleri	901 572 911	67,00
		Dikey montajlama desteği (WYC)		901 573 910	34,00
	YMV	Dikey Bağlantı Tabanı	Tek taraf	901 573 900	30,00
	YZV	Dikey Bağlantı Tabanı	Çift taraf	901 574 900	40,00
	YMR	Plastik Ayaklı Alüminyum Borulu Montaj Bağlantı Tabanı	100 mm	901 582 900	32,00
			250 mm	901 583 900	37,00
			400 mm	901 584 900	49,00
	YNW	Direk montaj tabanı	NPT 1/2" tel için	901 570 950	30,00
	XWR	Plastik Ayaklı Duvar Bağlantı Dirseği	XMR, YMR, ZMR için	900 600 900	21,00
	YSW	Cıvatalı Alüminyum Borulu Yatay Montaj Bağlantı Tabanı	100 mm	901 592 900	53,00
			250 mm	901 593 900	56,00
			400 mm	901 594 900	68,00







Tip	Model	Açıklama	Teknik Özellikler	Sip. No.	Sip. No.	Fiyat(€)
<b>eco 60</b>				<b>Siyah Gövde</b>		
	<b>XSS</b>	Dikey Bağlantı Tabanı	XSW, YSW, ZSW için	900 700 900		21,00
	<b>YFR</b>	Hızlı Bağlamak için Ayak Adaptörlü Alüminyum Borulu Montaj Tabanı	100 mm	901 562 900		86,00
			250 mm	901 563 900		89,00
			400 mm	901 564 900		104,00
	<b>YEP</b>	Taban Uzantısı100mm Boy	Tüm tabanlara uygun	901 800 900		11,00
<b>AKSESUARLAR</b>			<b>NET FİYAT</b>			
	<b>XIB</b>	Gösterge Paneli	bütün tabanlara uygun	900 850 900		41,00
	<b>LWW</b>	Ampul Değişirme Aparatı	opsiyonlu	890 900 900		10,00
<b>XMR Direk montaj tabanı için malzemeler</b>				<b>Siyah Gövde</b>		
	<b>BDW</b>	Yatay montaj için	Yatay montajlama için		841 50T 900	18,00
	<b>BDV</b>	Dikey montaj için	Dikey montajlama için		841 51T 900	27,00
	<b>BDM</b>	Mıknatıslı bağlantı kutusu	Manyetik montajlama için		841 52T 900	52,00
	<b>SKE</b>	Vidalama seti	ECOmodul70/60/40 ve modulCOMPACT70 Sinyal kuleleri ile bağlantılı direk bağlantı kutuları için kullanılır	841 000 900		9,00

Bağlantı Kodları T : 1 = M20; 2 = NPT 1/2"; 3 = PG 16



Tip	Model	Açıklama	Teknik Özellikler	Sip. No.	Fiyat(€)
		<p><b>Önceden yapılandırılmış ECOmodul40</b>  <b>Sinyal kuleleri 24 V AC/DC</b>  <b>LED sabit ışık modülleri ZDC</b>  <b>100mm alu-pole üzerinde plastik ayaklı direk montaj tabanı</b></p>			
	ECO40-Q01	ZDC LED sabit ışık kırmızı ZDC LED sabit ışık turuncu ZDC LED sabit ışık yeşil 100mm alu-tube/plastik ayaklı ZMR direk tabanı		ECO40-Q01	125,00
	ECO40-Q02	ZDC LED sabit ışık kırmızı ZDC LED sabit ışık yeşil 100mm alu-tube/plastik ayaklı ZMR direk tabanı		ECO40-Q02	94,00
	ECO40-Q05	ZDC LED sabit ışık kırmızı ZDC LED sabit ışık turuncu ZDC LED sabit ışık yeşil ZDC LED sabit ışık mavi 100mm alu-tube/plastik ayaklı ZMR direk tabanı		ECO40-Q05	157,00
	ECO40-Q31	ZDE piezo buzzer DEVAMLI ya da KESİKLİ ton ZDC LED sabit ışık kırmızı ZDC LED sabit ışık turuncu ZDC LED sabit ışık yeşil 100mm alu-tube/plastik ayaklı ZMR direk tabanı		ECO40-Q31	167,00
		<p><b>Önceden yapılandırılmış ECOmodul40</b>  <b>Sinyal Kuleleri 230/240 V AC</b>  <b>LED sabit ışık modülleri ZDC</b>  <b>100mm alu-pole üzerinde plastik ayaklı direk montaj tabanı</b></p>			
	ECO40-Q81	ZDE piezo buzzer DEVAMLI ya da KESİKLİ ton ZDC LED sabit ışık kırmızı ZDC LED sabit ışık turuncu ZDC LED sabit ışık yeşil 100mm alu-tube/plastik ayaklı ZMR direk tabanı		ECO40-Q81	173,00













Tip	Model	Açıklama	Teknik Özellikler	Sip. No.	Sip. No.	Fiyat(€)
<b>Birbirinden bağımsız yapılandırılabilir EComodul40 Sinyal Kuleleri</b>						
	ZLL	Sabit Yanan Lamba Turuncu, Kırmızı, Şeffaf, Yeşil Mavi, Sarı - IP65	250 V AC/DC' a kadar	902 00C 900		13,00
	ZDC	LED'li Sabit Yanan Lamba Turuncu, Sarı, Kırmızı, Yeşil IP65	24 V AC/DC	902 01C 405		32,00
			110/120 V AC	902 01C 310		33,00
			230/240 V AC	902 01C 313		33,00
		LED'li Sabit Yanan Lamba Mavi, Şeffaf IP65	24 V AC/DC	902 01C 405		33,00
			110/120 V AC	902 01C 310		35,00
			230/240 V AC	902 01C 313		35,00
	ZDA	LED'li Flaşörlü Lamba Turuncu, Sarı, Kırmızı, Yeşil IP65	24 V AC/DC	902 02C 405		33,00
			110/120 V AC	902 02C 310		35,00
			230/240 V AC	902 02C 313		35,00
		LED'li Flaşörlü Lamba Mavi, Şeffaf IP65	24 V AC/DC	902 02C 405		35,00
			110/120 V AC	902 02C 310		37,00
			230/240 V AC	902 02C 313		37,00
	ZDF	LED'li Çakar Lamba Turuncu, Sarı, Kırmızı, Yeşil IP65	24 V AC/DC	902 03C 405		35,00
			110/120 V AC	902 03C 310		37,00
			230/240 V AC	902 03C 313		37,00
		LED'li Çakar Lamba Mavi, Şeffaf IP65	24 V AC/DC	902 03C 405		37,00
			110/120 V AC	902 03C 310		40,00
			230/240 V AC	902 03C 313		40,00
	ZFF	LED'li Çoklu Çakar Lamba Turuncu, Sarı, Kırmızı, Yeşil IP65	24 V AC/DC	902 04C 405		40,00
			110/120 V AC	902 04C 310		42,00
			230/240 V AC	902 04C 313		42,00
		LED'li Çoklu Çakar Lamba Mavi, Şeffaf IP65	24 V AC/DC	902 04C 405		42,00
			110/120 V AC	902 04C 310		44,00
			230/240 V AC	902 04C 313		44,00

902 04C 405













Renkler : C : 1=Turuncu; 2=Kırmızı; 4=Şeffaf; 5=Mavi; 6=Yeşil; 7=Sarı



Tip	Model	Açıklama	Teknik Özellikler	Sip. No.	Sip. No.	Fiyat(€)
	<b>eco 40</b>				<b>Siyah Gövde</b>	
	<b>ZDE</b>	Piezo Buzzer Sürekli veya Kesik Kesik Ses85 dB	24 V AC/DC	902 500 405		43,00
			110/120 V AC	902 500 310		45,00
			230/240 V AC	902 500 313		45,00
	<b>ZMW</b>	Yatay Bağlantı Tabanı	içten montaj delikli	902 570 900		21,00
	<b>ZMS</b>	Yatay Bağlantı Tabanı	hazır sabitleme vidalı	902 571 900		25,00
	<b>ZMF</b>	Yatay Bağlantı Tabanı	dıştan montaj delikli	902 572 900		25,00
	<b>ZMC</b>	Yatay montajlama için 5 direk entegreli M12 bağlayıcı taban	Harici montaj delikleri	902 572 911		56,00
	<b>WZC</b>	Dikey montajlama için metal destek (modul70, ZMC)		200 550 900		34,00
	<b>ZMV</b>	Dikey Bağlantı Tabanı	Tek taraf	902 573 900		32,00
	<b>ZZV</b>	Dikey Bağlantı Tabanı	Çift taraf	902 574 900		40,00
	<b>ZMR</b>	Plastik Ayaklı Alüminyum Borulu Montaj Bağlantı Tabanı	100 mm	902 582 900		32,00
			250 mm	902 583 900		36,00
			400 mm	902 584 900		46,00
	<b>ZNW</b>	Direk montaj tabanı	NPT 1/2" tel için	902 570 950		26,00
	<b>XWR</b>	Direk montajı için plastik ayaklı destek	XMR, YMR, ZMR için	900 600 900		21,00



Tip	Model	Açıklama	Teknik Özellikler	Sip. No.	Sip. No.	Fiyat(€)
		<b>eco 40</b>			<b>Siyah Gövde</b>	
	<b>ZSW</b>	Civatalı Alüminyum Borulu Yatay Montaj Bağlantı Tabanı	100 mm	902 592 900		52,00
			250 mm	902 593 900		55,00
			400 mm	902 594 900		68,00
	<b>XSS</b>	Dikey Bağlantı Tabanı	XSW, YSW, ZSW için	900 700 900		21,00
	<b>ZFR</b>	Hızlı Bağlamak için Ayak Adaptörlü Alüminyum Borulu Montaj Tabanı	100 mm	902 562 900		53,00
			250 mm	902 563 900		56,00
			400 mm	902 564 900		71,00
	<b>ZEP</b>	Taban Uzatması 100mm Boy	Tüm tabanlara uygun	902 800 900		11,00
		<b>AKSESUARLAR</b>	<b>NET FİYAT</b>			
	<b>XIB</b>	Gösterge Paneli	bütün tabanlara uygun	900 850 900		41,00
	<b>LWW</b>	Ampul Değişirme Aparatı	opsiyonlu	890 900 900		10,00
		<b>XMR direk montaj tabanı için malzemeler</b>			<b>Siyah Gövde</b>	
	<b>BDW</b>	Yatay montaj için	Yatay montajlama için		841 50T 900	18,00
	<b>BDV</b>	Dikey montaj için	Dikey montajlama için		841 51T 900	27,00
	<b>BDM</b>	Mıknatıslı bağlantı kutusu	Manyetik montajlama için		841 52T 900	52,00
	<b>SKE</b>	Vidalama seti	ECOmodul70/60/40 ve modulCOMPACT70 Sinyal kuleleri ile bağlantılı direk bağlantı kutuları için kullanılır	841 000 900		9,00

Bağlantı Kodları T : 1 = M20; 2 = NPT 1/2"; 3 = PG 16



Tip	Model	Açıklama	Teknik Özellikler	Sip. No.	Sip. No.	Fiyat(€)	
			<b>Modul Signal 70</b>		<b>Gri Gövde</b>	<b>Siyah Gövde</b>	
	<b>SLL</b>	Sabit yanar ışık modülü Çap70 IP65	250 V AC/DC'a kadar	210 10C 900	210 50C 900	22,00	
	<b>SLB</b>	Yanıp sönen ışık modülü 70 mm IP65	12-24 V AC/DC	220 10C 405	220 50C 405	44,00	
			110/120 V AC	220 10C 310	220 50C 310	46,00	
			230/240 V AC	220 10C 313	220 50C 313	46,00	
	<b>SLF</b>	Çakan-Flaş ışık modülü 70mm IP65	12-24 V AC/DC	230 10C 405	230 50C 405	83,00	
			110/120 V AC	230 10C 310	230 50C 310	66,00	
			230/240 V AC	230 10C 313	230 50C 313	66,00	
	<b>SDC</b>	LED'li ışık modülü 70mm Sabit yanar Turuncu, Sarı, Kırmızı IP65	12 V AC/DC	211 10C 404	211 50C 404	57,00	
			24 V AC/DC	211 10C 405	211 50C 405	57,00	
			110/120 V AC	211 10C 310	211 50C 310	60,00	
			230/240 V AC	211 10C 313	211 50C 313	60,00	
		LED'li ışık modülü 70 mm Sabit yanar Mavi, Şeffaf, Yeşil IP65	12 V AC/DC	211 10C 404	211 50C 404	66,00	
	24 V AC/DC		211 10C 405	211 50C 405	66,00		
	110/120 V AC		211 10C 310	211 50C 310	72,00		
	230/240 V AC		211 10C 313	211 50C 313	72,00		
	<b>SDA</b>	LED'li yanıp sönen ikaz ışık 70mm Turuncu, Sarı, Kırmızı IP65	12 V AC/DC	221 10C 404	221 50C 404	58,00	
			24 V AC/DC	221 10C 405	221 50C 405	58,00	
			110/120 V AC	221 10C 310	221 50C 310	63,00	
			230/240 V AC	221 10C 313	221 50C 313	63,00	
		LED'li yanıp sönen ikaz ışık 70mm Mavi, Şeffaf, Yeşil IP65	12 V AC/DC	221 10C 404	221 50C 404	68,00	
	24 V AC/DC		221 10C 405	221 50C 405	68,00		
	110/120 V AC		221 10C 310	221 50C 310	69,00		
	230/240 V AC		221 10C 313	221 50C 313	69,00		
	<b>SDR</b>	LED'li Döner Işık Modülü 70mm Turuncu, Sarı, Kırmızı IP65	12 V AC/DC	231 10C 404	231 50C 404	60,00	
			24 V AC/DC	231 10C 405	231 50C 405	60,00	
			110/120 V AC	231 10C 310	231 50C 310	63,00	
			230/240 V AC	231 10C 313	231 50C 313	63,00	
		LED'li Döner Işık Modülü 70mm Mavi, Şeffaf, Yeşil IP65	12 V AC/DC	231 10C 404	231 50C 404	68,00	
	24 V AC/DC		231 10C 405	231 50C 405	68,00		
	110/120 V AC		231 10C 310	231 50C 310	69,00		
	230/240 V AC		231 10C 313	231 50C 313	69,00		

902 04C 405



Renkler : C : 1=Turuncu; 2=Kırmızı; 4=Şeffaf; 5=Mavi; 6=Yeşil; 7=Sarı













Tip	Model	Açıklama	Teknik Özellikler	Sip. No.	Sip. No.	Fiyat(€)	
			<b>Modul Signal 70</b>		<b>Gri Gövde</b>	<b>Siyah Gövde</b>	
	SLP	Sabit ışık-Buzzer li kombine modül DIP switch ses ayarlı 88-107 dB IP65	12 V AC/DC	250 10C 404	250 50C 404	51,00	
			24 V AC/DC	250 10C 405	250 50C 405	51,00	
			110/120 V AC	250 10C 310	250 50C 310	53,00	
			230/240 V AC	250 10C 313	250 50C 313	53,00	
	SLD	Sabit ışık-Buzzer li kombine modül Harici dıştan ses ayarlı 88-107 dB IP65	12 V AC/DC	212 10C 404	212 50C 404	50,00	
			24 V AC/DC	212 10C 405	212 50C 405	50,00	
			110/120 V AC	212 10C 310	212 50C 310	53,00	
			230/240 V AC	212 10C 313	212 50C 313	53,00	
	SBP	Yanıp sönen ışık Buzzer li Kombine Modül 88-107 dB IP65	12 V AC/DC	260 10C 404	260 50C 404	63,00	
			24 V AC/DC	260 10C 405	260 50C 405	63,00	
			110/120 V AC	260 10C 310	260 50C 310	66,00	
			230/240 V AC	260 10C 313	260 50C 313	66,00	
	SFP	Xenon lu Çakan ışık Kombine Modül Buzzer li 88-107 dB IP65	12 V AC/DC	270 10C 404	270 50C 404	101,00	
			24 V AC/DC	270 10C 405	270 50C 405	101,00	
			110/120 V AC	270 10C 310	270 50C 310	97,00	
			230/240 V AC	270 10C 313	270 50C 313	97,00	
	SCP	LED'li sabit ışık buzzer li Kombine modül 88-107 dB Turuncu, Sarı, Kırmızı IP65	12 V AC/DC	251 10C 404	251 50C 404	78,00	
			24 V AC/DC	251 10C 405	251 50C 405	78,00	
			110/120 V AC	251 10C 310	251 50C 310	81,00	
			230/240 V AC	251 10C 313	251 50C 313	81,00	
	SCP	LED'li sabit ışık buzzer li Kombine modül 88-107 dB Mavi, Şeffaf, Yeşil IP65	12 V AC/DC	251 10C 404	251 50C 404	87,00	
			24 V AC/DC	251 10C 405	251 50C 405	87,00	
			110/120 V AC	251 10C 310	251 50C 310	90,00	
			230/240 V AC	251 10C 313	251 50C 313	90,00	
	SAP	LED'li yanıp sönen ikaz ışık Buzzer li 88-107 dB Turuncu, Sarı, Kırmızı IP65	12 V AC/DC	261 10C 404	261 50C 404	78,00	
			24 V AC/DC	261 10C 405	261 50C 405	78,00	
			110/120 V AC	261 10C 310	261 50C 310	81,00	
			230/240 V AC	261 10C 313	261 50C 313	81,00	
	SAP	LED'li yanıp sönen ikaz ışık Buzzer li 88-107 dB Mavi, Şeffaf, Yeşil IP65	12 V AC/DC	261 10C 404	261 50C 404	83,00	
			24 V AC/DC	261 10C 405	261 50C 405	83,00	
			110/120 V AC	261 10C 310	261 50C 310	89,00	
			230/240 V AC	261 10C 313	261 50C 313	89,00	
	SRP	LED'li Dönen ışık Buzzer li Kombine modül 88-107 dB Turuncu, Sarı, Kırmızı IP65	12 V AC/DC	271 10C 404	271 50C 404	78,00	
			24 V AC/DC	271 10C 405	271 50C 405	78,00	
			110/120 V AC	271 10C 310	271 50C 310	81,00	
			230/240 V AC	271 10C 313	271 50C 313	81,00	
	SRP	LED'li Dönen ışık Buzzer li Kombine modül 88-107 dB Mavi, Şeffaf, Yeşil IP65	12 V AC/DC	271 10C 404	271 50C 404	83,00	
			24 V AC/DC	271 10C 405	271 50C 405	83,00	
			110/120 V AC	271 10C 310	271 50C 310	89,00	
			230/240 V AC	271 10C 313	271 50C 313	89,00	





Tip	Model	Açıklama	Teknik Özellikler	Sip. No.	Sip. No.	Fiyat(€)
	<b>Modul Signal 70</b>			<b>Gri Gövde</b>	<b>Siyah Gövde</b>	
	<b>SDE</b>	Piezo Buzzer Modülü daimi-Sürekli /kesik kesik ses DIP switch ayarlı88-107dB IP65	12 V AC/DC	247 100 404	247 500 404	44,00
			24 V AC/DC	247 100 405	247 500 405	44,00
			110/120 V AC	247 100 310	247 500 310	46,00
			230/240 V AC	247 100 313	247 500 313	46,00
	<b>SDZ</b>	Piezo Buzzer Modülü daimi-Sürekli / kesik kesik ses harici dıştan ayarlı 88-107dB IP 65	12 V AC/DC	248 100 404	248 500 404	49,00
			24 V AC/DC	248 100 405	248 500 405	49,00
			110/120 V AC	248 100 310	248 500 310	51,00
			230/240 V AC	248 100 313	248 500 313	51,00
	<b>SPE</b>	Piezo Buzzer Modülü daimi-sürekli / Kesik kesik ses DIP switch ses ayarlı 88 107dB IP54	12 V AC/DC	243 100 404	243 500 404	42,00
			24 V AC/DC	243 100 405	243 500 405	42,00
			110/120 V AC	243 100 310	243 500 310	43,00
			230/240 V AC	243 100 313	243 500 313	43,00
	<b>SPZ</b>	Piezo Buzzer Modülü daimi-sürekli / Kesik kesik ses harici dıştan ayarlı 88 107 dB IP54	12 V AC/DC	244 100 404	244 500 404	44,00
			24 V AC/DC	244 100 405	244 500 405	44,00
			110/120 V AC	244 100 310	244 500 310	45,00
			230/240 V AC	244 100 313	244 500 313	45,00
	<b>STE</b>	15 değişik elektronik ses modülü DIP switch ayarlı 88-107 dB IP54	12-24 V AC/DC	241 100 405	241 500 405	111,00
			110/120 V AC	241 100 310	241 500 310	111,00
			230/240 V AC	241 100 313	241 500 313	111,00
	<b>STZ</b>	15 Değişik elektronik ses modülü harici dıştan ayarlı 88-107dB IP 65	12-24 V AC/DC	242 100 405	242 500 405	113,00
			110/120 V AC	242 100 310	242 500 310	114,00
			230/240 V AC	242 100 313	242 500 313	114,00
	<b>BAZ</b>	AS-Ara yüz modülü	31 slaves/4 modül		280 500 510	127,00
			62 slaves/3 modül		280 500 000	127,00
			62 slaves/4 modül		280 500 100	127,00



Tip	Model	Açıklama	Teknik Özellikler	Sip. No.	Sip. No.	Fiyat(€)
<b>Modul Signal 70</b>				<b>Gri Gövde</b>	<b>Siyah Gövde</b>	
	<b>BMW</b>	Yatay montaj Bağlantı tabanı	M20	200 100 900	200 500 900	23,00
	<b>BNW</b>	Yatay montaj bağlantı tabanı	NPT 1/2"	200 130 900	200 530 900	23,00
	<b>BMV</b>	Dikey montaj bağlantı tabanı		200 200 900	200 600 900	32,00
	<b>BMR</b>	Alüminyum tüp üzerinde plastik ayaklı direk monte tabanı	50 mm	200 301 900	200 701 900	37,00
			100 mm	200 302 900	200 702 900	37,00
			250 mm	200 303 900	200 703 900	42,00
			400 mm	200 304 900	200 704 900	42,00
	<b>BSR</b>	Paslanmaz çelik tüp üzerinde çinko döküm kaplamalı direk monte tabanı	50 mm	200 311 900	200 711 900	56,00
			100 mm	200 312 900	200 712 900	57,00
			250 mm	200 313 900	200 713 900	66,00
			400 mm	200 314 900	200 714 900	75,00
	<b>BWS</b>	Yatay monteleme için alüminyum tüp üzerinde vidalı direk monte tabanı	50 mm	200 331 900	200 731 900	53,00
			100 mm	200 332 900	200 732 900	56,00
			250 mm	200 333 900	200 733 900	60,00
			400 mm	200 334 900	200 734 900	72,00
	<b>BSS</b>	Dikey monteleme seti	BWS' için	200 400 900	200 800 900	23,00
	<b>BFR</b>	Hızlı monteleme için ayak adaptörlü alüminyum tüp üzerinde direk monte tabanı	100 mm	200 342 900	200 742 900	89,00
			250 mm	200 343 900	200 743 900	92,00
			400 mm	200 344 900	200 744 900	101,00
<b>BMR direk monteleme tabanı için malzemeler</b>				<b>Gri Gövde</b>	<b>Siyah Gövde</b>	
	<b>BDW</b>	Yatay montaj için	Yatay montajlama için		841 50T 900	20,00
	<b>BDV</b>	Dikey montaj için	Dikey montajlama için		841 51T 900	29,00
	<b>BDM</b>	Mıknatıslı bağlantı kutusu	manyetik montajlama için		841 52T 900	55,00

Bağlantı Kodları T : 1 = M20; 2 = NPT 1/2"; 3 = PG 16



Tip	Model	Açıklama	Teknik Özellikler	Sip. No.	Sip. No.	Fiyat(€)
<b>Modul Signal 50</b>						
	<b>VLL</b>	Sabit yanar ışık modülü Ø50 mm - Ba 15 D Ampullu Turuncu, Kırmızı, Şeffaf, Mavi, Yeşil, Sarı - IP65	250 V AC/DC' a kadar	750 00C 900		17,00
	<b>VLB</b>	Yanıp sönen ışık modülü Ø50 mm - Ba 15 D Ampullu Turuncu, Kırmızı, Şeffaf, Mavi, Yeşil, Sarı - IP65	12-24 V AC/DC	760 00C 405		32,00
			110/120 V AC	760 00C 310		35,00
			230/240 V AC	760 00C 313		35,00
	<b>VDC</b>	Sabit yanar LED Ø50 mm - IP65 Turuncu, Kırmızı, Sarı, Yeşil	24 V AC/DC	751 00C 405		49,00
			110/120 V AC	751 00C 310		52,00
			230/240 V AC	751 00C 313		52,00
		Sürekli ışık LED Ø50 mm - IP65 Şeffaf, Mavi	24 V AC/DC	751 00C 405		58,00
			110/120 V AC	751 00C 310		61,00
			230/240 V AC	751 00C 313		61,00
	<b>VDA</b>	Yanıp sönen LED ışık Modülü Ø50 mm Turuncu, Kırmızı, Şeffaf, Mavi, Yeşil, Sarı - IP65	24 V AC/DC	761 00C 405		58,00
			110/120 V AC	761 00C 310		61,00
			230/240 V AC	761 00C 313		61,00
	<b>VDF</b>	Yanıp sönen LED Turuncu, Kırmızı, Şeffaf, Mavi, Yeşil, Sarı - IP65	24 V AC/DC	771 00C 405		61,00
			110/120 V AC	771 00C 310		65,00
			230/240 V AC	771 00C 313		65,00
	<b>VFF</b>	Çoklu yanıp sönen ışık LED Ø50 mm Turuncu, Kırmızı, Şeffaf, Mavi, Yeşil, Sarı - IP65	24 V AC/DC	772 00C 405		63,00
			110/120 V AC	772 00C 310		66,00
			230/240 V AC	772 00C 313		66,00
	<b>VLF</b>	X Zenon ampullu Çakan ışık modülü Ø50mm Turuncu, Kırmızı, Şeffaf, Mavi, Yeşil, Sarı - IP65	12-24 V AC/DC	770 00C 405		63,00
			110/120 V AC	770 00C 310		52,00
			230/240 V AC	770 00C 313		52,00
				<b>Gri Gövde</b>	<b>Siyah Gövde</b>	
	<b>VDE</b>	piezo Buzzer modül DIPswich ayarlı Sürekli yada kesik kesik Ø50 mm - IP65 103dB	12 V AC/DC	781 100 404	781 500 404	41,00
			24 V AC/DC	781 100 405	781 500 405	41,00
			110/120 V AC	781 100 310	781 500 310	43,00
			230/240 V AC	781 100 313	781 500 313	43,00
	<b>VDZ</b>	piezo Buzzer modül DIPswich dışardan ayarlı Sürekli yada kesik kesik Ø50 mm - IP65 103dB	12 V AC/DC	782 100 404	782 500 404	46,00
			24 V AC/DC	782 100 405	782 500 405	46,00
			110/120 V AC	782 100 310	782 500 310	49,00
			230/240 V AC	782 100 313	782 500 313	49,00



Tip	Model	Açıklama	Teknik Özellikler	Sip. No.	Sip. No.	Fiyat(€)
<b>Modul Signal 50</b>				<b>Gri Gövde</b>	<b>Siyah Gövde</b>	
	<b>VMW</b>	Yatay montaj bağlantı tabanı		790 120 900	790 520 900	21,00
	<b>VNW</b>	Yatay montaj bağlantı tabanı		790 130 900	790 530 900	21,00
	<b>VMV</b>	Dikey montaj bağlantı tabanı		790 140 900	790 540 900	26,00
	<b>VMR</b>	Plastik ayaklı alüminyum borulu montaj bağlantı tabanı	50 mm	790 141 900	790 541 900	33,00
			100 mm	790 142 900	790 542 900	34,00
			250 mm	790 143 900	790 543 900	37,00
			400 mm	790 144 900	790 544 900	41,00
	<b>VSR</b>	Çinko ayaklı paslanmaz çelik borulu özel toz boyalı montaj bağlantı tabanı	50 mm	790 151 900	790 551 900	53,00
			100 mm	790 152 900	790 552 900	59,00
			250 mm	790 153 900	790 553 900	68,00
			400 mm	790 154 900	790 554 900	72,00
	<b>VSW</b>	Metal ayaklı alüminyum boru montajlı bağlantı tabanı	50 mm	790 171 900	790 571 900	49,00
			100 mm	790 172 900	790 572 900	53,00
			250 mm	790 173 900	790 573 900	59,00
			400 mm	790 174 900	790 574 900	68,00
	<b>BSS</b>	dikey montaj bağlantı kit'i	VSW' için	200 400 900	200 800 900	21,00
				<b>Gri Gövde</b>	<b>Siyah Gövde</b>	
	<b>VFR</b>	Hızlı bağlantı için ayak adaptörlü alüminyum borulu bağlantı tabanı	100 mm	790 182 900	790 582 900	84,00
			250 mm	790 183 900	790 583 900	87,00
			400 mm	790 184 900	790 584 900	90,00
	<b>SIC</b>	Vidalama güvenlik seti		700 000 900		4,00
<b>VMR direk monte tabanı için malzemeler</b>				<b>Gri Gövde</b>	<b>Siyah Gövde</b>	
	<b>BDW</b>	Yatay montaj için	Yatay montajlama için		841 50T 900	18,00
	<b>BDV</b>	Dikey montaj için	Dikey montajlama için		841 51T 900	27,00
	<b>BDM</b>	Mıknatıslı bağlantı kutusu	manyetik montajlama için		841 52T 900	52,00

Bağlantı Kodları T : 1 = M20; 2 = NPT 1/2"; 3 = PG 16







770 00C 313

Renkler : C : 1=Turuncu; 2=Kırmızı; 4=Şeffaf; 5=Mavi; 6=Yeşil; 7=Sar



Tip	Model	Açıklama	Teknik Özellikler	Sip. No.	Sip. No.	Fiyat(€)
<p><b>Önceden yapılandırılmış modulCOMPACT70</b>  <b> sinyal kuleleri 24 V AC/DC</b>  <b>LED sabit ışık modülleri DLL</b>  <b>Ana Renk siyah 1m UL-kablo ile kablolu</b>  <b>100mm alu-pole üzerinde plastik ayaklı direk montaj tabanı</b></p>						
	C70-Q02	DLL LED Sabit yanar <b>Kırmızı</b> DLL LED Sabit yanar <b>Yeşil</b> DMR 100mm direk tabanı	C70P1C1B24L6L2	C70-Q02		133,00
	C70-Q01	DLL LED Sabit yanar <b>Kırmızı</b> DLL LED Sabit <b>Turuncu</b> DLL LED Sabit yanar <b>Yeşil</b> DMR 100mm direk tabanı	C70P1C1B24L6L1L2	C70-Q01		156,00
	C70-Q07	DLL LED Sabit yanar <b>Kırmızı</b> DLL LED Sabit yanar <b>Sarı</b> DLL LED Sabit yanar <b>Yeşil</b> DMR 100mm direk tabanı	C70P1C1B24L6L7L2	C70-Q07		156,00
	C70-Q41	DDZ buzzer SÜREKLİ/KESİKLİ DLL LED sabit yanar <b>Kırmızı</b> DLL LED sabit yanar <b>Turuncu</b> DLL LED sabit yanar <b>Yeşil</b> DMR 100mm direk tabanı.	C70P1C1B24L6L1L2DZ	C70-Q41		196,00
<p><b>Önceden yapılandırılmış modulCOMPACT70</b>  <b> sinyal kuleleri 24 V AC/DC</b>  <b>LED sabit ışık modülü DLL Ana renk Siyah 1m UL-kablolu</b>  <b>100m alu-pole üzerinde yatay montajlama için vidalı direk montaj tabanı</b></p>						
	C70-Q602	DLL LED sabit ışık <b>Kırmızı</b> DLL LED sabit ışık <b>Yeşil</b> DSW 100mm direk tabanı	C70T1C1B24L6L2	C70-Q602		161,00
	C70-Q601	DLL LED sabit ışık <b>Kırmızı</b> DLL LED sabit ışık <b>Turuncu</b> DLL LED sabit ışık <b>Yeşil</b> DSW 100mm direk tabanı	C70T1C1B24L6L1L2	C70-Q601		184,00
	C70-Q607	DLL LED sabit ışık <b>Kırmızı</b> DLL LED sabit ışık <b>Sarı</b> DLL LED sabit ışık <b>Yeşil</b> DSW 100mm direk tabanı	C70T1C1B24L6L7L2	C70-Q607		184,00
	C70-Q641	DDZ buzzer SAYAN/NABIZLI DLL LED sabit ışık <b>Kırmızı</b> DLL LED sabit ışık <b>Turuncu</b> DLL LED sabit ışık <b>Yeşil</b> DSW 100mm direk tabanı	C70T1C1B24L6L1L2DZ	C70-Q641		219,00
	BSS	Dikey monteleme seti	DSW için	200 400 900	200 800 900	21,00



Tip	Model	Açıklama	Teknik Özellikler	Sip. No.	Sip. No.	Fiyat(€)
<b>Individually configurable modulCOMPACT70 Signal Towers</b> <b>Minimum order quantity: 10 pcs.</b>						
	<b>DLL</b>	LED'li sabit yanan ışık modülü IP65	Turuncu / <b>San</b> / Kırmızı	L1/L2/L7	L1/L2/L7	28,00
			Yeşil / Şeffaf / Mavi	L6/L4/L5	L6/L4/L5	
	<b>DLB</b>	LED'li çakar ışık modülü IP65	Turuncu / <b>San</b> / Kırmızı	B1/B2/B7	B1/B2/B7	41,00
			Yeşil / Şeffaf / Mavi	B6/B4/B5	B6/B4/B5	
				<b>Gri Gövde G</b>	<b>Siyah Gövde B</b>	
	<b>DDD</b>	basınç buzzer	Devamlı ton, 100 dB	DD	DD	46,00
	<b>DDP</b>	basınç buzzer	Kesikli ton, 100 dB	DP	DP	46,00
	<b>DDZ</b>	basınç buzzer	devamlı/kesikli ton 100 dB	DZ	DZ	46,00
	<b>DMW</b>	Dikey monteleme tabanı	24 V AC/DC	B0	B0	72,00
			110/120 V AC	B0	B0	89,00
			230/240 V AC	B0	B0	89,00
	<b>DMV</b>	Dikey monteleme tabanı	24 V AC/DC	V0	V0	67,00
			110/120 V AC	V0	V0	84,00
			230/240 V AC	V0	V0	84,00
	<b>DSW</b>	vidalı alüminyum yatay monteleme tübü üzerinde direk monte tabanı	24 V AC/DC, 50mm	T0	T0	78,00
			24 V AC/DC, 100 mm	T1	T1	86,00
			24 V AC/DC, 250 mm	T2	T2	91,00
			24 V AC/DC, 400 mm	T4	T4	97,00
	vidalı alüminyum yatay monteleme tübü üzerinde direk monte tabanı	110/120 V AC, 50 mm	T0	T0	94,00	
		110/120 V AC, 100 mm	T1	T1	103,00	
		110/120 V AC, 250 mm	T2	T2	107,00	
		110/120 V AC, 400 mm	T4	T4	113,00	
	vidalı alüminyum yatay monteleme tübü üzerinde direk monte tabanı	230/240 V AC, 50 mm	T0	T0	94,00	
		230/240 V AC, 100 mm	T1	T1	103,00	
		230/240 V AC, 250 mm	T2	T2	107,00	
		230/240 V AC, 400 mm	T4	T4	113,00	
	<b>BSS</b>	Dikey monteleme seti	DSW için	200 400 900	200 800 900	21,00
	<b>DMR</b>	Plastik ayaklı alüminyum tüp üzerinde direk monte tabanı	24 V AC/DC, 50 mm	P0	P0	75,00
			24 V AC/DC, 100 mm	P1	P1	81,00
			24 V AC/DC, 250 mm	P2	P2	86,00
			24 V AC/DC, 400 mm	P4	P4	91,00
	Plastik ayaklı alüminyum tüp üzerinde direk monte tabanı	110/120 V AC, 50 mm	P0	P0	91,00	
		110/120 V AC, 100 mm	P1	P1	96,00	
		110/120 V AC, 250 mm	P2	P2	101,00	
		110/120 V AC, 400 mm	P4	P4	106,00	
	Plastik ayaklı alüminyum tüp üzerinde direk monte tabanı	230/240 V AC, 50 mm	P0	P0	91,00	
		230/240 V AC, 100 mm	P1	P1	96,00	
		230/240 V AC, 250 mm	P2	P2	101,00	
		230/240 V AC, 400 mm	P4	P4	106,00	
902 04C 313						
Renkler : C : 1=Turuncu; 2=Kırmızı; 4=Şeffaf; 5=Mavi; 6=Yeşil; 7=San						



Tip	Model	Açıklama	Teknik Özellikler	Sip. No.	Sip. No.	Fiyat(€)	
	<b>Modul Kompakt 70</b>			<b>Gri Gövde</b>	<b>Siyah Gövde</b>		
	<b>DFR</b>	Hızlı monteleme için ayak adaptörlü alüminyum tüp üzerine direk monte tabanı	24 V AC/DC, 100 mm	Q1	Q1	111,00	
			24 V AC/DC, 250 mm	Q2	Q2	115,00	
			24 V AC/DC, 400 mm	Q4	Q4	121,00	
		Hızlı monteleme için ayak adaptörlü alüminyum tüp üzerine direk monte tabanı	110/120 V AC, 100 mm	Q1	Q1	122,00	
			110/120 V AC, 250 mm	Q2	Q2	126,00	
			110/120 V AC, 400 mm	Q4	Q4	133,00	
		Hızlı monteleme için ayak adaptörlü alüminyum tüp üzerine direk monte tabanı	230/240 V AC, 100 mm	Q1	Q1	124,00	
			230/240 V AC, 250 mm	Q2	Q2	130,00	
			230/240 V AC, 400 mm	Q4	Q4	136,00	
		<b>C1</b>	UL kablo 1m uzunluğunda		C1	C1	5,00
		<b>C2</b>	UL kablo 2m uzunluğunda		C2	C2	5,00
		<b>C3</b>	UL kablo 3m uzunluğunda		C3	C3	10,00
<b>C5</b>	UL kablo 5m uzunluğunda		C5	C5	17,00		
	<b>DMR direk monte tabanları için malzemeler</b>			<b>Siyah Gövde</b>			
	<b>BDW</b>	Yatay montaj için	Yatay montajlama için		841 50T 900	18,00	
	<b>BDV</b>	Dikey montaj için	Dikey montajlama için		841 51T 900	27,00	
	<b>BDM</b>	Mıknatıslı bağlantı kutusu	Manyetik montajlama için		841 52T 900	52,00	
	<b>SKE</b>	Vidalama seti	ECOmodul70/60/40 ve modulCOMPACT70 Sinyal kuleleri ile bağlantılı direk bağlantı kutuları için kullanılır	841 000 900		9,00	
		Bağlantı Kodları <b>T</b> : 1 = M20; 2 = NPT 1/2"					
		<b>Lütfen istediğiniz sinyal kulelerini yeni belirtilen numara kodları ile sipariş veriniz !</b>					



## modulCOMPACT70 LED sinyal kuleleri için tanımlayıcı sipariş numaraları

	Taban	Kablo	Gövde Rengi	Nominal voltaj	Modul Pozisyon A	Modul Pozisyon B	Modul Pozisyon C	Modul Pozisyon D	Modul Pozisyon E
C70	T2	C5	B	24	L 6	B 2			

Taban			
B0	DMW	Yatay montajlama tabanı	
V0	DMV	Dikey montajlama tabanı	
P0	DMR	Alüminyum tüp üzerinde plastik ayaklı direk montaj tabanı	
P1	DMR		50 mm
P2	DMR		100 mm
P4	DMR		250 mm
T0	DSW	Yatay montajlama için alüminyum tüp üzerinde vidalı direk montaj tabanı	
T1	DSW		50 mm
T2	DSW		100 mm
T4	DSW		250 mm
Q1	DFR	Hızlı montaj için ayak adaptörlü alüminyum tüp üzerinde direk montaj tabanı	
Q2	DFR		400 mm
Q4	DFR		100 mm
			250 mm
			400 mm

Standart UL kablo, yeşil	
C1	1 m
C2	2 m
C3	3 m
C5	5 m

Temel Renk	
B	siyah
G	gri

Nominal Voltaj	
24	24 V AC/DC
10	110/120 V AC
20	230/240 V AC

Modüller		
L	DLL	LED sabit ışık (1 Pozisyon)
B	DLB	LED Flaşlı ışık (1 Pozisyon)
DD	DDD	Piezo buzzer, Sürekli ton, 100 dB (1 pozisyon)
DP	DDP	Piezo buzzer, Kesikli ton, 100 dB (1 pozisyon)
DZ	DDZ	Piezo buzzer, sürekli ya da kesikli ton, 100 dB, haricen değiştirilebilir (2 pozisyon)

Lens Rengi	
1	turuncu
2	kırmızı
4	şeffaf
5	mavi
6	yeşil
7	sarı



### Aksesuarlar

Tip	Çeşit	Renk	Sipariş Numarası
BSS	Yatay montaj seti (DSW için)	siyah	200 800 900
BSS	Dikey montaj seti(DSWiçin)	gri	200 400 900







### modulCOMPACT70 LED Sinyal kulesi siparişi doğru verilimi

Konfigürasyon	Tip	Yeni	Doğru sipariş numarası
LED flaşlı ışık, Kırmızı	DLB	B2	<b>C70T2C5B24L6B2</b>
LED sabit ışık, Yeşil	DLL	L6	
Nominal voltaj 24 V AC/DC		24	
Hemel renk siyah		B	
Kablo 5 m		C5	
250 mm Alüminyum tüp üzerine vidalı direk montaj tabanı 250 mm	DSW	T2	
<b>Ek malzeme (Ayrı bir sipariş numarası ile sipariş edilmeli.):</b>			
Dikey montaj seti (DSW için), siyah	BSS		<b>200 800 900</b>



Tip	Model	Açıklama	Teknik Özellikler	Sip. No.	Sip. No.	Fiyat(€)
<p><b>Önceden yapılandırılmış modulCOMPACT30 sinyal kulesi 24 V AC/DC</b>  <b>LED sabit ışık modülüCLL temel rengi siyah 1m UL-kablolu</b>  <b>Omm alu-pole üzerinde plastik ayaklı direk desteği</b></p>						
	C30-Q02	CLL LED sabit ışık Kırmızı CLL LED sabit ışık Yeşil CMR Omm direk tabanı	C30POC1B24L6L2	C30-Q02		87,00
	C30-Q01	CLL LED sabit ışık Kırmızı CLL LED sabit ışık Turuncu CLL LED sabit ışık Yeşil CMR Omm direk tabanı	C30POC1B24L6L1L2	C30-Q01		107,00
	C30-Q07	CLL LED sabit ışık Kırmızı CLL LED sabit ışık Sarı CLL LED sabit ışık Yeşil CMR Omm direk tabanı	C30POC1B24L6L7L2	C30-Q07		107,00
	C30-Q41	CDZ buzzer sürekli/kesikli CLL LED sabit ışık Kırmızı CLL LED sabit ışık Turuncu CLL LED sabit ışık Yeşil CMR Omm direk tabanı	C30POC1B24L6L1L2DZ	C30-Q41		151,00
<p><b>Önceden yapılandırılmış modül COMPACT30 sinyal kuleleri 24 V AC/DC</b>  <b>LED sabit ışık modül CLL temel rengi siyah 1m UL-kablolu</b>  <b>Omm alu-pole üzerinde yatay montajlama için vidalı direk desteği</b></p>						
	C30-Q602	CLL LED sabit ışık Kırmızı CLL LED sabit ışık Yeşil CSW Omm Direk temeli	C30TOC1B24L6L2	C30-Q602		104,00
	C30-Q601	CLL LED sabit ışık Kırmızı CLL LED sabit ışık Turuncu CLL LED sabit ışık Yeşil CSW Omm Direk temeli	C30TOC1B24L6L1L2	C30-Q601		122,00
	C30-Q607	CLL LED sabit ışık Kırmızı CLL LED sabit ışık Sarı CLL LED sabit ışık Yeşil CSW Omm Direk temeli	C30TOC1B24L6L7L2	C30-Q607		122,00
	C30-Q641	CDZ buzzer sürekli/kesikli CLL LED sabit ışık Kırmızı CLL LED sabit ışık Turuncu CLL LED sabit ışık Yeşil CSW Omm Direk temeli	C30TOC1B24L6L1L2DZ	C30-Q641		166,00
	CSS	Dikey montajlama seti	CSW için	700 130 900	700 530 900	21,00



Tip	Model	Açıklama	Teknik Özellikler	Sip. No.	Sip. No.	Fiyat(€)
<b>Birbirinden bağımsız ayarlanabilir modulCOMPACT30 sinyal kuleleri Minimum sipariş miktarı 10 adet.</b>				<b>Gri Gövde</b>	<b>Siyah Gövde</b>	
	<b>CLL</b>	LED sabit yanan ikaz ışığı modülü IP65 LED sabit ışık	Turuncu / Kırmızı / Sarı	L1/L2/L7	L1/L2/L7	22,00
			Yeşil / Şeffaf / Mavi	L6/L4/L5	L6/L4/L5	
	<b>CLB</b>	LED yanıp sönen ikaz ışığı modülü IP65	Turuncu / Kırmızı / Sarı	B1/B2/B7	B1/B2/B7	30,00
			Yeşil / Şeffaf / Mavi	B6/B4/B5	B6/B4/B5	
				<b>Gri Gövde G</b>	<b>Siyah Gövde B</b>	
	<b>CDD</b>	piezo buzzer 85 dB	Devamlı ton	DD	DD	51,00
	<b>CDP</b>	piezo buzzer 85 dB	Kesikli ton	DP	DP	51,00
	<b>CDZ</b>	piezo buzzer 85 dB	devamlı/kesikli ton	DZ	DZ	51,00
		Alüminyum tüp üzerinde yatay montajlama için vidalı direk desteği	24 V AC/DC, 0 mm	T0	T0	71,00
			24 V AC/DC, 100 mm	T1	T1	64,00
			24 V AC/DC, 250 mm	T2	T2	79,00
			24 V AC/DC, 400 mm	T4	T4	83,00
		Alüminyum tüp üzerinde yatay montajlama için vidalı direk desteği	110/120 V AC, 0 mm	T0	T0	83,00
			110/120 V AC, 100 mm	T1	T1	86,00
			110/120 V AC, 250 mm	T2	T2	90,00
			110/120 V AC, 400 mm	T4	T4	96,00
		Alüminyum tüp üzerinde yatay montajlama için vidalı direk desteği	230/240 V AC, 0 mm	T0	T0	83,00
			230/240 V AC, 100 mm	T1	T1	86,00
			230/240 V AC, 250 mm	T2	T2	90,00
			230/240 V AC, 400 mm	T4	T4	96,00
	<b>CSS</b>	Montaj takımı	CSW' için	700 130 900	700 530 900	21,00



Tip	Model	Açıklama	Teknik Özellikler	Sip. No.	Sip. No.	Fiyat(€)
<b>Birbirinden bağımsız ayarlanabilir modulCOMPACT30 sinyal kuleleri Minimum sipariş miktarı 10 adet</b>				<b>Gri Gövde</b>	<b>Siyah Gövde</b>	
	<b>CMR</b>	Alüminyum tüp üzerinde plastik ayaklı direk desteği	24 V AC/DC, 0 mm	P0	P0	52,00
			24 V AC/DC, 100 mm	P1	P1	57,00
			24 V AC/DC, 250 mm	P2	P2	61,00
			24 V AC/DC, 400 mm	P4	P4	67,00
		Alüminyum tüp üzerinde plastik ayaklı direk desteği	110/120 V AC, 0 mm	P0	P0	65,00
			110/120 V AC, 100 mm	P1	P1	69,00
			110/120 V AC, 250 mm	P2	P2	73,00
			110/120 V AC, 400 mm	P4	P4	79,00
		Alüminyum tüp üzerinde plastik ayaklı direk desteği	230/240 V AC, 0 mm	P0	P0	65,00
			230/240 V AC, 100 mm	P1	P1	69,00
			230/240 V AC, 250 mm	P2	P2	73,00
			230/240 V AC, 400 mm	P4	P4	79,00
	<b>CFR</b>	Alüminyum tüp üzerinde hızlı montaj için ayak adaptörlü direk desteği	24 V AC/DC, 0 mm	Q0	Q0	102,00
			24 V AC/DC, 100 mm	Q1	Q1	106,00
			24 V AC/DC, 250 mm	Q2	Q2	110,00
			24 V AC/DC, 400 mm	Q4	Q4	113,00
		Alüminyum tüp üzerinde hızlı montaj için ayak adaptörlü direk desteği	110/120 V AC, 0 mm	Q0	Q0	113,00
			110/120 V AC, 100 mm	Q1	Q1	115,00
			110/120 V AC, 250 mm	Q2	Q2	120,00
			110/120 V AC, 400 mm	Q4	Q4	125,00
		Alüminyum tüp üzerinde hızlı montaj için ayak adaptörlü direk desteği	230/240 V AC, 0 mm	Q0	Q0	113,00
			230/240 V AC, 100 mm	Q1	Q1	115,00
			230/240 V AC, 250 mm	Q2	Q2	120,00
			230/240 V AC, 400 mm	Q4	Q4	125,00
<b>C1</b>	UL kablo 1m uzunluğunda		C1	C1		
<b>C2</b>	UL kablo 2m uzunluğunda		C2	C2	5,00	
<b>C3</b>	UL kablo 3m uzunluğunda		C3	C3	10,00	
<b>C5</b>	UL kablo 5m uzunluğunda		C5	C5	17,00	
<b>Lütfen istediğiniz sinyal kulelerini açıklamadaki numara kodları ile sipariş ediniz !</b>						



## modulCOMPACT30 LED Sinyal Kuleleri için tanımlayıcı sipariş numaraları

	Taban	Kablo	Gövde Rengi	Nominal voltaj	Modül Pozisyon A		Modül Pozisyon B		Modül Pozisyon C		Modül Pozisyon D		Modül Pozisyon E	
C30	P1	C1	B	20	B	1	L	5	L	4	B	2	D	P

Base			
P0	CMR		0 mm
P1	CMR	Alüminyum tüp üzerinde plastik ayaklı direk montaj tabanı	100 mm
P2	CMR		250 mm
P4	CMR		400 mm
T0	CSW		0 mm
T1	CSW	Alüminyum tüp üzerinde yatay montajlama için vidalı direk montaj tabanı	100 mm
T2	CSW		250 mm
T4	CSW		400 mm
Q0	CFR		0 mm
Q1	CFR	Hızlı montajlama için alüminyum tüp üzerinde ayak adaptörlü direk montaj tabanı	100 mm
Q2	CFR		250 mm
Q4	CFR		400 mm

Standart UL kablo, sarı	
C1	1 m
C2	2 m
C3	3 m
C5	5 m

Temel renk	
B	siyah
G	gri

Nominal voltaj	
24	24 V AC/DC
10	110/120 V AC
20	230/240 V AC

Modules			
L	CLL	LED sabit ışık (1 position)	
B	CLB	Yanıp sönen LED (1 position)	
DD	CDD	Piezo buzzer, sürekli ton, 85 dB (1 position)	
DP	CDP	Piezo buzzer, kesikli ton, 85 dB (1 position)	
DZ	CDZ	Piezo buzzer, sürekli ve kesik ton, 85 dB (2 positions)	

Lens rengi	
1	turuncu
2	kırmızı
4	şeffaf
5	mavi
6	yeşil
7	sarı



### Aksesuarlar

Tip	Tanım	Renk	Sipariş numarası
CSS	Dikey montaj seti (CSW için)	siyah	700 530 900
CSS	Dikey montaj seti (CSW için)	gri	700 130 900

Pozisyon E

Pozisyon D

Pozisyon C

Pozisyon B

Pozisyon A



modulCOMPACT30 LED sinyal kulesi siparişini doğru vermek için :

Konfigürasyon	Tip	Yeni	Doğru sipariş numarası
Buzzer kesikli ton	CDP	DP	<b>C30P1C1B20B1L5L4B2DP</b>
LED flaşlı ışık, Kırmızı	CLB	B2	
LED sabit ışık, şeffaf	CLL	L4	
LED sabit ışık, Mavi	CLL	L5	
LED flaşlı ışık, Turuncu	CLB	B1	
Nominal voltaj 230 V		20	
Temel rengi siyah		B	
1 m kablo		C1	
alu-tube üzerinde plastik ayaklı direk montaj tabanı, 100 mm	CMR	P1	











# CT5

Modul - Compete 50 İkaz Kulesi





## Ø50 mm "CT5" Serisi İkaz Kuleleri

Tip	Model	Açıklama	Teknik Özellikler	Sip. No.	Fiyat(€)
	<b>CT5DC</b>	LED Sabit Yanan Işık Modülü 24 V DC - IP65 Turuncu, Kırmızı, Şeffaf Mavi, Yeşil, Sarı	24 V DC	915 01C 005	22,00
	<b>CT5DF</b>	LED Sabit, Flaşör Çoklu Çakar Yanan Işık Modülü 24 V DC - IP65 Turuncu, Kırmızı, Şeffaf Mavi, Yeşil, Sarı	24 V DC	915 02C 005	34,00
Renkler : C : 1=Turuncu; 2=Kırmızı; 4=Şeffaf; 5=Mavi; 6=Yeşil; 7=Sarı					
	<b>CT5ZM</b>	Piezo Buzzer Modülü 8 Farklı Ses - 95 dB - DIP Switch 24 V DC - IP65	24 V DC	915 510 005	42,00
	<b>CT5MW</b>	Yatay Montaj Tabanı IP65	24 V DC	915 710 900	32,00
	<b>CT5MC5</b>	5-Pin M12 Bağlantı Elemanı Entegreli Taban IP65	24 V DC	915 781 005	42,00
	<b>CT5MV</b>	Dikey Montaj Tabanı IP65	24 V DC	915 730 900	41,00
	<b>CT5NPT</b>	NPT 1/2" Boru Montaj için Taban IP65	24 V DC	915 715 900	40,00
	<b>CT5KR1</b>	Montaj Tabanı H: 100 mm Plastik Tüp Boru Ayak IP65	24 V DC	915 742 910	42,00
	<b>CT5MR2</b>	Montaj Tabanı H: 250 mm Alüminyum Tüp Boru Ayak IP65	24 V DC	915 743 900	50,00
	<b>CT5MR3</b>	Montaj Tabanı H: 400 mm Alüminyum Tüp Boru Ayak IP65	24 V DC	915 744 900	68,00



## Ø50 mm "CT5" Serisi İkaz Kulesi Aksesuarları

Tip	Model	Açıklama	Sip. No.	Fiyat(€)
	<b>CT5SK</b>	Vida Seti	915 710 910	6,00
	<b>CT5BR</b>	Metal Köşebent Harici Kablo İlavesi İçin CT5NPT ile Birlikte Kullanılır	915 735 900	19,00
	<b>CKV</b>	Kablo Bağlantısı CT5NPT ile Birlikte Kullanılır	698 800 045	9,00
	<b>WM22</b>	Metal Köşebent M22 Montaj Çapı Olan Ürünler İçin CT5MC5 ile Birlikte Kullanılır	812 100 900	15,00

## Ø50 mm "CT5" Serisi İkaz Kuleleri

Tip	Model	Açıklama	Sip. No.	Fiyat(€)
	<b>CT5-Q01</b>	Model Perfect 50 24 V DC - IP65  CT5DC - 915 012 005 - Led Sabit Işık, <b>Kırmızı</b> CT5DC - 915 011 005 - Led Sabit Işık, <b>Turuncu</b> CT5DC - 915 016 005 - Led Sabit Işık, <b>Yeşil</b> CT5KR1 - 915 742 910 - Montaj Tabanı - H: 100 mm.	CT5-Q01	107,00
	<b>CT5-Q02</b>	Model Perfect 50 24 V DC - IP65  CT5DC - 915 012 005 - Led Sabit Işık, <b>Kırmızı</b> CT5DC - 915 016 005 - Led Sabit Işık, <b>Yeşil</b> CT5KR1 - 915 742 910 - Montaj Tabanı - H: 100 mm.	CT5-Q02	86,00
	<b>CT5-Q05</b>	Model Perfect 50 24 V DC - IP65  CT5DC - 915 012 005 - Led Sabit Işık, <b>Kırmızı</b> CT5DC - 915 011 005 - Led Sabit Işık, <b>Turuncu</b> CT5DC - 915 016 005 - Led Sabit Işık, <b>Yeşil</b> CT5DC - 915 015 005 - Led Sabit Işık, <b>Mavi</b> CT5KR1 - 915 742 910 - Montaj Tabanı - H: 100 mm.	CT5-Q05	129,00
	<b>CT5-Q031</b>	Model Perfect 50 24 V DC - IP65  CT5DC - 915 012 005 - Led Sabit Işık, <b>Kırmızı</b> CT5DC - 915 011 005 - Led Sabit Işık, <b>Turuncu</b> CT5DC - 915 016 005 - Led Sabit Işık, <b>Yeşil</b> CT5ZM - 915 510 005 - Buzzer, 8 Farklı Ses, 95 dB CT5KR1 - 915 742 910 - Montaj Tabanı - H: 100 mm.	CT5-Q031	149,00









# PC7

Modul - Compete 70 İkaz Kulesi













## Ø70 mm "PC7" Serisi İkaz Kuleleri

Tip	Model	Açıklama	Teknik Özellikler	Sip. No.	Fiyat(€)
	PC7DC	LED Sabit Yanan Işık Modülü 24 V AC/DC - IP66 Turuncu, Kırmızı, Şeffaf Mavi, Yeşil, Sarı, Magenta	24 V AC/DC	910 01C 405	43,00
	PC7DF	LED Sabit, Flaş, Çakar ve Çoklu Çakar 24 V AC/DC - IP66 Turuncu, Kırmızı, Şeffaf Mavi, Yeşil, Sarı, Magenta	24 V AC/DC	910 02C 405	55,00
	PC7DR	LED Dönen Işık Modülü - İki Farklı Hız 24 V AC/DC - IP66 Turuncu, Kırmızı, Şeffaf Mavi, Yeşil, Sarı, Magenta	24 V AC/DC	910 03C 405	83,00
	PC7DM	LED Çok Renkli, Sabit Yanan Işık Modülü 24 V AC/DC - IP66 Turuncu, Kırmızı, Şeffaf Mavi, Yeşil, Sarı, Magenta	24 V AC/DC	910 04C 405	122,00
	PC7DCB	"Üst Modül" LED Yanıp Sönen Işık Modülü 24 V AC/DC - IP66 Turuncu, Kırmızı, Şeffaf Mavi, Yeşil, Sarı, Magenta	24 V AC/DC	910 11C 405	69,00
	PC7DFB	"Üst Modül" LED Çakar ve Çoklu Çakar Işık Modülü 24 V AC/DC - IP66 Turuncu, Kırmızı, Şeffaf Mavi, Yeşil, Sarı, Magenta	24 V AC/DC	910 12C 405	74,00
	PC7DRB	"Üst Modül" LED Dönen Işık Modülü - İki Farklı Hız 24 V AC/DC - IP66 Turuncu, Kırmızı, Şeffaf Mavi, Yeşil, Sarı, Magenta	24 V AC/DC	910 13C 405	88,00
	PC7DMB	"Üst Modül" LED Çok Renkli, Sabit Yanan Işık Modülü 24 V AC/DC - IP66 Turuncu, Kırmızı, Şeffaf Mavi, Yeşil, Sarı, Magenta	24 V AC/DC	910 14C 405	127,00

Renkler : C : 1=Turuncu; 2=Kırmızı; 4=Şeffaf; 5=Mavi; 6=Yeşil; 7=Sarı; 8=Magenta



## Ø70 mm "PC7" Serisi İkaz Kuleleri

Tip	Model	Açıklama	Teknik Özellikler	Sip. No.	Fiyat(€)
	<b>PC7ZM</b>	<b>"Üst Modül"</b> Piezo Buzzer DIP switch ayarlı - 8 Farklı Ses 24 V AC/DC - IP66 105 dB	24 V AC/DC	910 510 405	48,00
	<b>PC7ZI</b>	Piezo Buzzer DIP switch ayarlı - 8 Farklı Ses 24 V AC/DC - IP66 102 dB	24 V AC/DC	910 520 405	59,00
	<b>PC7TD</b>	<b>"Üst Modül"</b> Piezo Buzzer DIP switch ayarlı - 16 Farklı Ses 24 V AC/DC - IP66 105 dB	24 V AC/DC	910 530 405	82,00
	<b>PC7VS</b>	<b>"Üst Modül"</b> Piezo Buzzer MP3 Ses Çıkış Modülü Mesaj ve Sesler Harici Değiştirilebilir 24 V AC/DC - IP66 95 dB	24 V AC/DC	910 540 405	259,00
	<b>PC7MW</b>	Dikey Montaj Tabanı NPT 1/2", Dahili Montaj Delikli 24 V AC/DC - IP66	24 V AC/DC	910 710 900	14,00
	<b>PC7MS</b>	Dikey Montaj Tabanı NPT 1/2", Montaj Edilmiş Vidalı 24 V AC/DC - IP66	24 V AC/DC	910 720 900	21,00
	<b>PC7MV</b>	Duvar Montaj Tabanı 24 V AC/DC - IP66	24 V AC/DC	910 730 900	13,00
	<b>PC7MP</b>	Duvar Montaj Tabanı Ø 25 mm Tüp Boru İçin 24 V AC/DC - IP66	24 V AC/DC	910 760 900	22,00



## Ø70 mm "PC7" Serisi İkaz Kuleleri

Tip	Model	Açıklama	Teknik Özellikler	Sip. No.	Fiyat(€)
	PC7MR	Dikey Montaj Tabanı Alüminyum Tüp Boru, Plastik Ayak 24 V AC/DC - IP66	h: 100 mm	910 742 900	33,00
			h: 250 mm	910 743 900	40,00
			h: 400 mm	910 744 900	56,00
			h: 600 mm	910 746 900	79,00
			h: 800 mm	910 747 900	98,00
	PC7RS	Dikey Montaj Tabanı Vidalı Alüminyum Boru Taban 24 V AC/DC - IP66	h: 100 mm	910 752 900	46,00
			h: 250 mm	910 753 900	58,00
	PC7MC5	Dikey Montaj Tabanı 5 Pinli M12 Konnektörlü 24 V AC/DC - IP66	24 V AC/DC	910 781 405	41,00
	PC7MC8	Dikey Montaj Tabanı 8 Pinli M12 Konnektörlü 24 V AC/DC - IP66	24 V AC/DC	910 782 405	104,00
	PC7FR	Dikey Montaj Tabanı Hızlı Montaj Sistemi Alüminyum Tüp Boru, Plastik Ayak 24 V AC/DC - IP66	h: 100 mm	910 792 405	166,00
			h: 250 mm	910 793 405	153,00
	PC7TM	"Modül - Signal 70" için Geçiş Modülü 24 V AC/DC - 240 V AC IP65	24 V AC/DC 240 V AC	910 800 900	41,00
	PC7BLV	24 V AC/DC Bağlantı Aparatı 7 Modüle Kadar 24 V AC/DC - IP66	24 V AC/DC	910 771 405	18,00

## Ø70 mm "PC7" Serisi İkaz Kuleleri

Tip	Model	Açıklama	Teknik Özellikler	Sip. No.	Fiyat(€)
	PC7BHV3	120 - 240 V AC Bağlantı Aparatı 3 Modüle Kadar IP66	120 - 240 V AC	910 772 313	37,00
	PC7BHV7	120 - 240 V AC Bağlantı Aparatı 7 Modüle Kadar IP66	120 - 240 V AC	910 773 313	69,00
	PC7ASI20	AS-Arayüz Modülü 4 Modüle Kadar Jumper ile Değřtirilebilir IP66	31 Bağımlı Birim İin	910 775 200	133,00
			62 Bağımlı Birim İin	910 775 300	133,00

## Ø70 mm "PC7" Serisi İkaz Kulesi Aksesuarları





Tip	Model	Açıklama	Sip. No.	Fiyat(€)
	WZC	Metal Dirsek Herhangi Bir Yönden Kablo Giriři PC7MW İin	200 550 900	32,00
	XSS	Dikey Montaj Ayar Seti PC7RS İin	900 700 900	20,00
	XWR	Dikey Montaj İin Plastik Dirsek PC7MR	900 600 900	20,00
	PC7LD	Difüzör Folyo 2'li Set	910 000 900	6,00



**Ø70 mm "PC7" Serisi İkaz Kuleleri**

Tip	Model	Açıklama	Sip. No.	Fiyat(€)
	<b>PC7-Q01</b>	<p>Model Perfect 70 24 V AC/DC - IP66</p> <p>PC7DC - 910 012 405 - Led Sabit Işık, <b>Kırmızı</b>            PC7DC - 910 011 405 - Led Sabit Işık, <b>Turuncu</b>            PC7DC - 910 016 405 - Led Sabit Işık, <b>Yeşil</b>            PC7BLV - 910 771 405 - 24 V AC/DC Bağlantı Aparatı            PC7MR - 910 742 900 - Montaj Tabanı - H: 100 mm.</p>	<b>PC7-Q01</b>	178,00
	<b>PC7-Q02</b>	<p>Model Perfect 70 24 V AC/DC - IP66</p> <p>PC7DC - 910 012 405 - Led Sabit Işık, <b>Kırmızı</b>            PC7DC - 910 016 405 - Led Sabit Işık, <b>Yeşil</b>            PC7BLV - 910 771 405 - 24 V AC/DC Bağlantı Aparatı            PC7MR - 910 742 900 - Montaj Tabanı - H: 100 mm.</p>	<b>PC7-Q02</b>	135,00
	<b>PC7-Q05</b>	<p>Model Perfect 70 24 V AC/DC - IP66</p> <p>PC7DC - 910 012 405 - Led Sabit Işık, <b>Kırmızı</b>            PC7DC - 910 011 405 - Led Sabit Işık, <b>Turuncu</b>            PC7DC - 910 016 405 - Led Sabit Işık, <b>Yeşil</b>            PC7DC - 910 015 405 - Led Sabit Işık, <b>Mavi</b>            PC7BLV - 910 771 405 - 24 V AC/DC Bağlantı Aparatı            PC7MR - 910 742 900 - Montaj Tabanı - H: 100 mm.</p>	<b>PC7-Q05</b>	220,00
	<b>PC7-Q06</b>	<p>Model Perfect 70 24 V AC/DC - IP66</p> <p>PC7DF - 910 022 405 - Led Sabit, Flaşör, Çakar ve Çoklu Çakar, <b>Kırmızı</b>            PC7DC - 910 011 405 - Led Sabit Işık, <b>Turuncu</b>            PC7DC - 910 016 405 - Led Sabit Işık, <b>Yeşil</b>            PC7BLV - 910 771 405 - 24 V AC/DC Bağlantı Aparatı            PC7MR - 910 742 900 - Montaj Tabanı - H: 100 mm.</p>	<b>PC7-Q06</b>	188,00
	<b>PC7-Q07</b>	<p>Model Perfect 70 24 V AC/DC - IP66</p> <p>PC7DCB - 910 112 405 - Led Sabit veya Flaşör Işık, <b>Kırmızı</b>            PC7DC - 910 011 405 - Led Sabit Işık, <b>Turuncu</b>            PC7DC - 910 016 405 - Led Sabit Işık, <b>Yeşil</b>            PC7BLV - 910 771 405 - 24 V AC/DC Bağlantı Aparatı            PC7MR - 910 742 900 - Montaj Tabanı - H: 100 mm.</p>	<b>PC7-Q07</b>	204,00



Tip	Model	Açıklama	Sip. No.	Fiyat(€)
<b>Önceden yapılandırılmış halfDOME90</b> <b> sinyal kuleleri LED sabit ışık modülleri (HDL)</b> <b>24 V AC/DC</b> <b>Gövde Rengi Gri (RAL 7035)</b>				
	<b>HD90-Q02</b>	HDL LED sabit ışık Kırmızı HDL LED sabit ışık Yeşil	HDG24L6L2	173,00
	<b>HD90-Q32</b> 90 dB - IP65	HDL LED sabit ışık Kırmızı HDL LED sabit ışık Yeşil HDZ buzzer SÜREKLİ/KESİKLİ ton	HDG24L6L2DZ	172,00
	<b>HD90-Q01</b>	HDL LED sabit ışık Kırmızı HDL LED sabit ışık Turuncu HDL LED sabit ışık Yeşil	HDG24L6L1L2	203,00
	<b>HD90-Q31</b> 90 dB - IP65	HDL LED sabit ışık Kırmızı HDL LED sabit ışık Turuncu HDL LED sabit ışık Yeşil HDZ buzzer SÜREKLİ/KESİKLİ ton	HDG24L6L1L2DZ	219,00
	<b>HD90-Q07</b>	HDL LED sabit ışık Kırmızı HDL LED sabit ışık Sarı HDL LED sabit ışık Yeşil	HDG24L6L7L2	203,00
	<b>HD90-Q37</b> 90 dB - IP65	HDL LED sabit ışık Kırmızı HDL LED sabit ışık Sarı HDL LED sabit ışık Yeşil HDZ buzzer SÜREKLİ/KESİKLİ ton	HDG24L6L7L2DZ	219,00
	<b>HD90-Q35</b> 90 dB - IP65	HDL LED sabit ışık Kırmızı HDL LED sabit ışık Turuncu HDL LED sabit ışık Yeşil HDL LED sabit ışık Mavi HDZ buzzer SÜREKLİ/KESİKLİ ton	HDG24L5L6L1L2DZ	273,00
	<b>HD90-Q34</b> 90 dB - IP65	HDL LED sabit ışık Kırmızı HDL LED sabit ışık Turuncu HDL LED sabit ışık Yeşil HDL LED steady light CLEAR HDZ buzzer SÜREKLİ/KESİKLİ ton	HDG24L4L6L1L2DZ	273,00
	<b>HD90-Q39</b> 90 dB - IP65	HDL LED sabit ışık Kırmızı HDL LED sabit ışık Sarı HDL LED sabit ışık Yeşil HDL LED sabit ışık Mavi HDZ buzzer SÜREKLİ/KESİKLİ ton	HDG24L5L6L7L2DZ	273,00
	<b>HD90-Q1039</b> 90 dB - IP65	HDL LED sabit ışık Kırmızı HDL LED sabit ışık Sarı HDL LED sabit ışık Yeşil HDL LED sabit ışık Şeffaf HDZ buzzer SÜREKLİ/KESİKLİ ton	HDG24L4L6L7L2DZ	273,00
	<b>HD90-Q36</b> 90 dB - IP65	HDL LED sabit ışık Kırmızı HDL LED sabit ışık Turuncu HDL LED sabit ışık Yeşil HDL LED sabit ışık Mavi HDL LED sabit ışık Şeffaf HDZ buzzer SÜREKLİ/KESİKLİ ton	HDG24L4L5L6L1L2DZ	288,00
	<b>HD90-Q1036</b> 90 dB - IP65	HDL LED sabit ışık Kırmızı HDL LED sabit ışık Sarı HDL LED sabit ışık Yeşil HDL LED sabit ışık Mavi HDL LED sabit ışık Şeffaf HDZ buzzer SÜREKLİ/KESİKLİ ton	HDG24L4L5L6L7L2DZ	288,00



Tip	Model	Açıklama	Sip. No.	Fiyat(€)
<b>Önceden yapılandırılmış halfDOME90 sinyal kuleleri LED sabit ışık modülleri (HDL) 230/240 V AC Gövde Rengi Gri (RAL 7035)</b>				
	<b>HD90-Q52</b>	HDL LED sabit ışık Kırmızı HDL LED sabit ışık Yeşil	<b>HDG20L6L2</b>	184,00
	<b>HD90-Q82</b> 90 dB - IP65	HDL LED sabit ışık Kırmızı HDL LED sabit ışık Yeşil HDZ buzzer SÜREKLİ/KESİKLİ ton	<b>HDG20L6L2DZ</b>	196,00
	<b>HD90-Q51</b>	HDL LED sabit ışık Kırmızı HDL LED sabit ışık Turuncu HDL LED sabit ışık Yeşil	<b>HDG20L6L1L2</b>	219,00
	<b>HD90-Q81</b> 90 dB - IP65	HDL LED sabit ışık Kırmızı HDL LED sabit ışık Turuncu HDL LED sabit ışık Yeşil HDZ buzzer SÜREKLİ/KESİKLİ ton	<b>HDG20L6L1L2DZ</b>	230,00
	<b>HD90-Q57</b>	HDL LED sabit ışık Kırmızı HDL LED sabit ışık Sarı HDL LED sabit ışık Yeşil	<b>HDG20L6L7L2</b>	219,00
	<b>HD90-Q87</b> 90 dB - IP65	HDL LED sabit ışık Kırmızı HDL LED sabit ışık Sarı HDL LED sabit ışık Yeşil HDZ buzzer SÜREKLİ/KESİKLİ ton	<b>HDG20L6L7L2DZ</b>	230,00



Tip	Model	Açıklama	Sip. No.	Fiyat(€)
<b>Önceden yapılandırılmış halfDOME90</b> <b>sinyal kuleleri LED sabit ışık modülleri (HDL)</b> <b>24 V AC/DC</b> <b>Gövde Rengi Krom</b>				
	<b>HD90-Q12</b>	HDL LED sabit ışık <b>Kırmızı</b> HDL LED sabit ışık <b>Yeşil</b>	<b>HDC24L6L2</b>	170,00
	<b>HD90-Q42</b> 90 dB - IP65	HDL LED sabit ışık <b>Kırmızı</b> HDL LED sabit ışık <b>Yeşil</b> HDZ buzzer SÜREKLİ/KESİKLİ ton	<b>HDC24L6L2DZ</b>	190,00
	<b>HD90-Q11</b>	HDL LED sabit ışık <b>Kırmızı</b> HDL LED sabit ışık <b>Turuncu</b> HDL LED sabit ışık <b>Yeşil</b>	<b>HDC24L6L1L2</b>	210,00
	<b>HD90-Q41</b> 90 dB - IP65	HDL LED sabit ışık <b>Kırmızı</b> HDL LED sabit ışık <b>Turuncu</b> HDL LED sabit ışık <b>Yeşil</b> HDZ buzzer SÜREKLİ/KESİKLİ ton	<b>HDC24L6L1L2DZ</b>	221,00
	<b>HD90-Q17</b>	HDL LED sabit ışık <b>Kırmızı</b> HDL LED sabit ışık <b>Sarı</b> HDL LED sabit ışık <b>Yeşil</b>	<b>HDC24L6L7L2</b>	210,00
	<b>HD90-Q47</b> 90 dB - IP65	HDL LED sabit ışık <b>Kırmızı</b> HDL LED sabit ışık <b>Sarı</b> HDL LED sabit ışık <b>Yeşil</b> HDZ buzzer SÜREKLİ/KESİKLİ ton	<b>HDC24L6L7L2DZ</b>	221,00
<b>Önceden yapılandırılmış halfDOME90</b> <b>sinyal kuleleri LED sabit ışık modül (HDL)</b> <b>230/240 V AC</b> <b>Gövde Rengi Krom</b>				
	<b>HD90-Q62</b>	HDL LED sabit ışık <b>Kırmızı</b> HDL LED sabit ışık <b>Yeşil</b>	<b>HDC20L6L2</b>	184,00
	<b>HD90-Q92</b> 90 dB - IP65	HDL LED sabit ışık <b>Kırmızı</b> HDL LED sabit ışık <b>Yeşil</b> HDZ buzzer SÜREKLİ/KESİKLİ ton	<b>HDC20L6L2DZ</b>	196,00
	<b>HD90-Q61</b>	HDL LED sabit ışık <b>Kırmızı</b> HDL LED sabit ışık <b>Turuncu</b> HDL LED sabit ışık <b>Yeşil</b>	<b>HDC20L6L1L2</b>	219,00
	<b>HD90-Q91</b> 90 dB - IP65	HDL LED sabit ışık <b>Kırmızı</b> HDL LED sabit ışık <b>Turuncu</b> HDL LED sabit ışık <b>Yeşil</b> HDZ buzzer SÜREKLİ/KESİKLİ ton	<b>HDC20L6L1L2DZ</b>	230,00
	<b>HD90-Q67</b>	HDL LED sabit ışık <b>Kırmızı</b> HDL LED sabit ışık <b>Sarı</b> HDL LED sabit ışık <b>Yeşil</b>	<b>HDC20L6L7L2</b>	219,00
	<b>HD90-Q97</b> 90 dB - IP65	HDL LED sabit ışık <b>Kırmızı</b> HDL LED sabit ışık <b>Sarı</b> HDL LED sabit ışık <b>Yeşil</b> HDZ buzzer SÜREKLİ/KESİKLİ ton	<b>HDC20L6L7L2DZ</b>	230,00



Tip	Model	Açıklama	Sip. No.	Fiyat(€)
<b>Önceden yapılandırılmış halfDOME90</b> <b>Sinyal Kuleleri LED Sabit ışık modülleri (HDL)</b> <b>24 V AC/DC</b> <b>Gövde Rengi Siyah</b>				
	HD90-Q22	HDL LED sabit ışık Kırmızı HDL LED sabit ışık Yeşil	HDB24L6L2	170,00
	HD90-Q952	HDL LED sabit ışık Kırmızı HDL LED sabit ışık Yeşil HDZ buzzer SÜREKLİ/KESİKLİ ton	HDB24L6L2DZ	190,00
	HD90-Q21	HDL LED sabit ışık Kırmızı HDL LED sabit ışık Turuncu HDL LED sabit ışık Yeşil	HDB24L6L1L2	210,00
	HD90-Q951	HDL LED sabit ışık Kırmızı HDL LED sabit ışık Turuncu HDL LED sabit ışık Yeşil HDZ buzzer SÜREKLİ/KESİKLİ ton	HDB24L6L1L2DZ	221,00
	HD90-Q27	HDL LED sabit ışık Kırmızı HDL LED sabit ışık Sarı HDL LED sabit ışık Yeşil	HDB24L6L7L2	210,00
	HD90-Q957	HDL LED sabit ışık Kırmızı HDL LED sabit ışık Sarı HDL LED sabit ışık Yeşil HDZ buzzer SÜREKLİ/KESİKLİ ton	HDB24L6L7L2DZ	221,00
<b>Önceden yapılandırılmış halfDOME90</b> <b>sinyal kuleleri LED sabit ışık modülü (HDL)</b> <b>230/240 V AC</b> <b>Gövde Rengi Siyah</b>				
	HD90-Q72	HDL LED sabit ışık Kırmızı HDL LED sabit ışık Yeşil	HDB20L6L2	184,00
	HD90-Q992	HDL LED sabit ışık Kırmızı HDL LED sabit ışık Yeşil HDZ buzzer SÜREKLİ/KESİKLİ ton	HDB20L6L2DZ	196,00
	HD90-Q71	HDL LED sabit ışık Kırmızı HDL LED sabit ışık Turuncu HDL LED sabit ışık Yeşil	HDB20L6L1L2	219,00
	HD90-Q991	HDL LED sabit ışık Kırmızı HDL LED sabit ışık Turuncu HDL LED sabit ışık Yeşil HDZ buzzer SÜREKLİ/KESİKLİ ton	HDB20L6L1L2DZ	230,00
	HD90-Q77	HDL LED sabit ışık Kırmızı HDL LED sabit ışık Sarı HDL LED sabit ışık Yeşil	HDB20L6L7L2	219,00
	HD90-Q997	HDL LED sabit ışık Kırmızı HDL LED sabit ışık Sarı HDL LED sabit ışık Yeşil HDZ buzzer SÜREKLİ/KESİKLİ ton	HDB20L6L7L2DZ	230,00



Tip	Model	Açıklama	Teknik Özellikler	Sip. No.	Fiyat(€)	Sip. No.	Sip. No.	Fiyat(€)	
<b>Birbirinden ayrı olarak ayarlanabilir HalfDome90 modelleri Minimum sipariş sayısı 5 parça</b>									
	HDL	LED sabit ışık	turuncu/kırmızı/sarı	L1/L2/L7	30,00				
			yeşil/şeffaf/mavi	L6/L4/L5	30,00				
	HDB	LED flaşlı ışık	turuncu/kırmızı/sarı	B1/B2/B7	33,00				
			yeşil/şeffaf/mavi	B6/B4/B5	33,00				
	HDX	piezo buzzer	sürekli/kesikli ton	DZ	12,00				
					<b>Gövde Gri G</b>	<b>Gri</b>	<b>Gövde Krom C</b>	<b>Gövde Siyah B</b>	<b>Krom Siyah</b>
	HDX	2 renk için gövde	12 V AC/DC		113,00			121,00	
	HDX	3 renk için gövde	12 V AC/DC		129,00			135,00	
	HDX	4 renk için gövde	12 V AC/DC		165,00			172,00	
	HDX	5 renk için gövde	12 V AC/DC		175,00			181,00	
								0,00	
	HDX	2 renk için gövde	24 V AC/DC		113,00			121,00	
	HDX	3 renk için gövde	24 V AC/DC		129,00			135,00	
	HDX	4 renk için gövde	24 V AC/DC		165,00			172,00	
	HDX	5 renk için gövde	24 V AC/DC		175,00			181,00	
						0,00			
	HDX	2 renk için gövde	110/120 V AC		120,00			129,00	
	HDX	3 renk için gövde	110/120 V AC		130,00			137,00	
	HDX	4 renk için gövde	110/120 V AC		179,00			183,00	
	HDX	5 renk için gövde	110/120 V AC		187,00			194,00	
HDX	2 renk için gövde	230/240 V AC		120,00			129,00		
HDX	3 renk için gövde	230/240 V AC		130,00			137,00		
HDX	4 renk için gövde	230/240 V AC		179,00			183,00		
HDX	5 renk için gövde	230/240 V AC		187,00			194,00		
<b>Lütfen siparişinizi belirtilen numara kodlarını kullanarak veriniz !</b>									



## halfDOME90 LED sinyal kuleleri için tanımlayıcı sipariş numaraları

	Gövde rengi	Nominal voltaj	Modül Pozisyon A		Modül Pozisyon B		Modül Pozisyon C		Modül Pozisyon D		Modül Pozisyon E		Ton Modül	
HD	C	24	L	6	B	7	L	2	B	5	L	4	D	Z

Gövde rengi	
G	gri
C	krom
B	siyah

Nominal voltaj	
12	12 V AC/DC
24	24 V AC/DC
10	110/120 V AC
20	230/240 V AC

Modül		
L	HDL	LED sabit ışık LED flaşlı ışık
B	HDB	LED flaşlı ışık
DZ	HDZ	Buzzer sürekli/kesikli ton 70-90 dB

Lens rengi	
1	turuncu
2	kırmızı
4	şeffaf
5	mavi
6	yeşil
7	sarı

### BİLGİ:

yarımDOME LED sinyal kuleleri are 4 temel modelidir:

HD2	2 ışıklı
HD3	3 ışıklı
HD4	4 ışıklı
HD5	5 ışıklı



### Doğru şekilde halfDOME90 LED sinyal kulesi siparişi vermeniz için

Konfigürasyon	Tip	Yeni	Doğru sipariş numarası
Buzzer sürekli/kesikli ton	HDZ	DZ	<b>HDC24L6B7L2B5L4DZ</b>
LED sabit ışık, şeffaf	HDL	L4	
LED flaşlı ışık, Mavi	HDB	B5	
LED sabit ışık, Kırmızı	HDL	L2	
LED flaşlı ışık, Sarı	HDB	B7	
LED sabit ışık, Yeşil	HDL	L6	
Nominal voltaj 24 V AC/DC		24	
Temel rengi krom		C	
5 ışıklı	HD5		



### NOT:

Işık modülleri halfDOME ürünler içeren nominal montaj 24V AC/DC, 110/120V AC ve 230/240 V AC ile çalışan ve sadece 24V çalıştırılan montajlıdır. Sadece 12V AC/DC modelleri 12V voltaj ile çalıştırılabilir

Ürünün sevkinden sonra ışık modüllerinin dizayn sebebinden dolayı değiştirilmesi mümkün değildir!..

# OPTİK - AKUSTİK SİNYALLER









Tip	Model	Açıklama	Teknik Özellikler	Sip. No.	Sip. No.	Fiyat(€)
<b>Çok Sesli Siren "A" - Lamba "Q" Boy 1</b>				<b>Kırmızı Gövde</b>		
	<b>ASS-P</b>	Çok Sesli Elektronik Siren 8 Farklı Ses -103 dB Boy 1 - IP66	24 V AC/DC	874 060 405		79,00
			48 V AC/DC	874 060 408		79,00
			110-120 V AC	874 060 310		99,00
			230-240 V AC	874 060 313		99,00
	<b>ASS-T</b>	Çok Sesli Elektronik Siren 32 Farklı Ses - 108 dB Boy 1 - IP66	24-48 V AC/DC	874 170 408		101,00
			110-240 V AC	874 170 313		127,00
	<b>QDS</b>	LED'li Sabit Yanan / Flaşörlü Lamba Boy 1 - IP66 Turuncu, Kırmızı, Şeffaf, Mavi, Yeşil, Sarı,	24 V AC/DC	874 16C 405		87,00
			48 V AC/DC	874 16C 408		87,00
			110-120 V AC	874 16C 310		104,00
			230-240 V AC	874 16C 313		104,00
	<b>QFS</b>	Xenon ampullü Çakar Lamba Boy 1 Turuncu, Kırmızı, Şeffaf, Mavi, Yeşil, Sarı,	24-48 V AC/DC, 5 J	874 56C 408		90,00
			110-120 V AC, 5 J	874 56C 310		87,00
230-240 V AC, 5 J			874 56C 313		87,00	
<b>Çok Sesli Siren "A" - Lamba "Q" Boy 2</b>				<b>Kırmızı Gövde</b>		
	<b>ASM</b>	Çok Sesli Elektronik Siren 32 Farklı Ses - 113 dB Boy 2 - IP66	24-48 V AC/DC	874 270 408		136,00
			110-240 V AC	874 270 313		173,00
	<b>QDM</b>	LED'li Sabit Yanan / Flaşörlü Lamba Boy 2 - IP66 Turuncu, Kırmızı, Şeffaf, Mavi, Yeşil, Sarı,	24-48 V AC/DC	874 26C 408		150,00
			110-240 V AC/DC	874 26C 413		150,00
	<b>QFM</b>	Xenon Ampullü Çakar Lamba Boy 2 - IP66 Turuncu, Kırmızı, Şeffaf, Mavi, Yeşil, Sarı,	24-48 V AC/DC, 10 J	874 66C 408		136,00
			110-120 V AC, 10 J	874 66C 310		133,00
230-240 V AC, 10 J			874 66C 313		133,00	
<b>Çok Sesli Siren "A" - Lamba "Q" Boy 3</b>				<b>Kırmızı Gövde</b>		
	<b>ASL</b>	Çok Sesli Elektronik Siren 63 Farklı Ses - 120 dB Boy 3 - IP66	24-48 V AC/DC	874 360 408		311,00
			110-120 V AC	874 360 310		322,00
			230-240 V AC	874 360 313		322,00
	<b>QDL</b>	LED'li Sabit Yanan / Flaşörlü Lamba Boy 3 - IP66 Turuncu, Sarı, Kırmızı, Şeffaf	24-48 V AC/DC	874 36C 408		334,00
			110-240 V AC/DC	874 36C 413		357,00
			LED'li Sabit Yanan / Flaşörlü Lamba Boy 3 - IP66 Mavi, Yeşil	24-48 V AC/DC	874 36C 408	
	<b>QBL</b>	LED'li Çoklu Çakar Lamba Boy 3 - IP66 Turuncu, Sarı, Kırmızı, Şeffaf	110-240 V AC/DC	874 36C 413		397,00
			24-48 V AC/DC	874 76C 408		344,00
			110-240 V AC/DC	874 76C 413		357,00
			LED'li Çoklu Çakar Lamba Boy 3 - IP66 Mavi, Yeşil	24-48 V AC/DC	874 76C 408	
			110-240 V AC/DC	874 76C 413		406,00

Renkler : C = 1=Turuncu; 2=Kırmızı; 4=Şeffaf; 5=Mavi; 6=Yeşil; 7=Sarı



Tip	Model	Açıklama	Teknik Özellikler	Sip. No.	Sip. No.	Fiyat(€)
<b>Çok sesli Siren kombinasyonları "A" - İşaret kulesi "Q" Boy 4</b>				<b>Kırmızı Gövde</b>		
	<b>ASX</b>	Çok sesli Elektronik Siren 63 farklı ses 127 dB Boy 4 - IP66	24-48 V AC/DC	874 460 408		515,00
			110-120 V AC	874 460 310		610,00
			230-240 V AC	874 460 313		610,00
	<b>QDX</b>	LED sabit / flaşlı işaret lambası Boy 4 - IP66 Turuncu, Kırmızı, Sarı, Şeffaf	24-48 V AC/DC	874 46C 408		617,00
			110-240 V AC/DC	874 46C 413		617,00
			24-48 V AC/DC	874 46C 408		686,00
	<b>QBX</b>	LED çoklu çakan işaret lambası Boy 4 - IP66 Turuncu, Kırmızı, Sarı, Şeffaf	110-240 V AC/DC	874 46C 413		708,00
			24-48 V AC/DC	874 86C 408		627,00
			110-240 V AC/DC	874 86C 413		627,00
	<b>QBX</b>	LED çoklu çakan işaret lambası Boy 4 - IP66 Mavi Yeşil	24-48 V AC/DC	874 86C 408		696,00
			110-240 V AC/DC	874 86C 413		720,00
			24-48 V AC/DC	874 86C 408		696,00
<b>Işıklı Çok Sesli Siren "A" Boy 1</b>						
	<b>ADS-P</b>	Işıklı Çok Sesli Elektronik Siren 8 Farklı Ses - 103 dB Boy 1 - IP66 Turuncu, Sarı, Kırmızı	24 V AC/DC	875 06C 405		121,00
			110-120 V AC	875 06C 310		150,00
			230-240 V AC	875 06C 313		150,00
	<b>ADS-P</b>	Işıklı Çok Sesli Elektronik Siren 8 Farklı Ses - 103 dB Boy 1 - IP66 Mavi, Şeffaf, Yeşil	24 V AC/DC	875 06C 405		133,00
			110-120 V AC	875 06C 310		157,00
			230-240 V AC	875 06C 313		157,00
	<b>ADS-T</b>	"Işıklı Çok Sesli Elektronik Siren 32 Farklı Ses - 108 dB Boy 1 - IP66 Turuncu, Sarı, Kırmızı	24 V AC/DC	875 16C 405		144,00
			110-240 V AC	875 17C 313		173,00
	<b>ADS-T</b>	"Işıklı Çok Sesli Elektronik Siren 32 Farklı Ses - 108 dB Boy 1 - IP66 Mavi, Şeffaf, Yeşil	24 V AC/DC	875 16C 405		157,00
			110-240 V AC	875 17C 313		181,00
<b>Işıklı Çok Sesli Siren "A" Boy 2</b>						
	<b>ADM</b>	Işıklı Çok Sesli Elektronik Siren 32 Farklı Ses - 113 dB Boy 2 - IP66 Turuncu, Sarı, Kırmızı	24 V AC/DC	875 26C 405		199,00
			110-120 V AC	875 26C 310		240,00
			230-240 V AC	875 26C 313		240,00
	<b>ADM</b>	Işıklı Çok Sesli Elektronik Siren 32 Farklı Ses - 113 dB Boy 2 - IP66 Mavi, Şeffaf, Yeşil	24 V AC/DC	875 26C 405		230,00
			110-120 V AC	875 26C 310		253,00
			230-240 V AC	875 26C 313		253,00
	<b>ACM</b>	Çakar Işıklı Çok Sesli Elektronik Siren 32 Farklı Ses - 113 dB Boy 2 - IP66 Turuncu, Sarı, Kırmızı	24 V AC/DC	875 66C 405		203,00
			110-120 V AC	875 66C 310		242,00
			230-240 V AC	875 66C 313		242,00
	<b>ACM</b>	Çakar Işıklı Çok Sesli Elektronik Siren 32 Farklı Ses - 113 dB Boy 2 - IP66 Mavi, Şeffaf, Yeşil	24 V AC/DC	875 66C 405		213,00
			110-120 V AC	875 66C 310		251,00
			230-240 V AC	875 66C 313		251,00
<b>LED-Flashing Beacon- Multitone Siren</b>				<b>Kırmızı Gövde</b>	<b>Beyaz Gövde</b>	
	<b>CS1</b>	Işıklı Çok Sesli Elektronik Siren 88 - 109 dB - Ø63 mm Turuncu, Kırmızı	24 V DC	C111 62C 005	C111 22C 005	133,00
			Lens Rengi C: 1, 2, 4, 5			



Tip	Model	Açıklama	Teknik Özellikler	Sip. No.	Sip. No.	Fiyat(€)
<b>Işıklı Çok Sesli Siren "A" Boy 3</b>						
	<b>ADL</b>	Işıklı Çok Sesli Elektronik Siren 63 Farklı Ses - 120 dB - Boy 3 - IP66 Turuncu, Sarı, Kırmızı	24 V AC/DC	875 36C 405		371,00
			110-120 V AC	875 36C 310		382,00
			230-240 V AC	875 36C 313		382,00
		Işıklı Çok Sesli Elektronik Siren 63 Farklı Ses - 120 dB - Boy 3 - IP66 Mavi, Şeffaf, Yeşil	24 V AC/DC	875 36C 405		382,00
			110-120 V AC	875 36C 310		413,00
			230-240 V AC	875 36C 313		413,00
	<b>ACL</b>	Çakar Işıklı Çok Sesli Elektronik Siren 63 Farklı Ses - 120 dB - Boy 3 - IP66 Turuncu, Sarı, Kırmızı	24 V AC/DC	875 76C 405		382,00
			110-120 V AC	875 76C 310		395,00
			230-240 V AC	875 76C 313		395,00
		Çakar Işıklı Çok Sesli Elektronik Siren 63 Farklı Ses - 120 dB - Boy 3 - IP66 Mavi, Şeffaf, Yeşil	24 V AC/DC	875 76C 405		393,00
			110-120 V AC	875 76C 310		405,00
			230-240 V AC	875 76C 313		405,00
<b>Işıklı Çok Sesli Siren "A" Boy 3</b>						
	<b>ADX</b>	Işıklı Çok Sesli Elektronik Siren 63 Farklı Ses - 127 dB - Boy 4 - IP66 Turuncu, Sarı, Kırmızı	24 V AC/DC	875 46C 405		577,00
			110-120 V AC	875 46C 310		650,00
			230-240 V AC	875 46C 313		650,00
		Işıklı Çok Sesli Elektronik Siren 63 Farklı Ses - 127 dB - Boy 4 - IP66 Mavi, Şeffaf, Yeşil	24 V AC/DC	875 46C 405		586,00
			110-120 V AC	875 46C 310		702,00
			230-240 V AC	875 46C 313		702,00
	<b>ACX</b>	Çakar Işıklı Çok Sesli Elektronik Siren 63 Farklı Ses - 127 dB - Boy 4 - IP66 Turuncu, Sarı, Kırmızı	24 V AC/DC	875 86C 405		1041,00
			110-120 V AC	875 86C 310		684,00
			230-240 V AC	875 86C 313		684,00
		Çakar Işıklı Çok Sesli Elektronik Siren 63 Farklı Ses - 127 dB - Boy 4 - IP66 Mavi, Şeffaf, Yeşil	24 V AC/DC	875 86C 405		597,00
			110-120 V AC	875 86C 310		696,00
			230-240 V AC	875 86C 313		696,00
<b>Buzzerli Lamba "Q" Boy 1</b>						
	<b>QSS</b>	Işıklı Buzzerli sabit yanan / Flaşörlü 85 dB - Boy 1 - IP66 Turuncu, Sarı, Kırmızı	24 V AC/DC	876 16C 405		129,00
			110-120 V AC	876 16C 310		148,00
			230-240 V AC	876 16C 313		148,00
	<b>QTS</b>	Xenon Ampullü Buzzerli Çakar Lamba - 85 dB Boy 1 - IP66	24 V AC-DC, 5 J	876 56C 405		133,00
			110-120 V AC, 5 J	876 56C 310		156,00
			230-240 V AC, 5 J	876 56C 313		156,00
<b>Buzzerli Lamba "Q" Boy 2</b>						
	<b>QSM</b>	Işıklı Buzzerli sabit yanan / Flaşörlü 100 dB - Boy 2 - IP66 Turuncu, Sarı, Kırmızı	24 V AC-DC	876 26C 405		196,00
			110-120 V AC	876 26C 310		196,00
			230-240 V AC	876 26C 313		196,00
	<b>QTM</b>	Xenon Ampullü Buzzerli Çakar Lamba 100 dB - Boy 2 - IP66 Turuncu, Kırmızı, Şeffaf, Mavi, Yeşil, Sarı	24 V AC-DC, 10 J	876 66C 405		196,00
			110-120 V AC, 10 J	876 66C 310		196,00
			230-240 V AC, 10 J	876 66C 313		196,00



Tip	Model	Açıklama	Teknik Özellikler	Sip. No.	Sip. No.	Fiyat(€)
<b>Buzzerli Lamba "Q" Boy 3</b>				<b>Gövde Kırmızı</b>		
	<b>QSL</b>	Işıklı Buzzerli sabit yanan / Flaşörlü 105 dB - Boy 3 - IP66 <b>Turuncu, Sarı, Kırmızı, Şeffaf</b>	24 V AC/DC	876 36C 405		414,00
			110-120 V AC	876 36C 310		433,00
			230-240 V AC	876 36C 313		433,00
		Işıklı Buzzerli sabit yanan / Flaşörlü 105 dB - Boy 3 - IP66 <b>Mavi, Yeşil</b>	24 V AC/DC	876 36C 405		451,00
			110-120 V AC	876 36C 310		489,00
			230-240 V AC	876 36C 313		489,00
	<b>QCL</b>	Işıklı Buzzerli Çoklu Çakar Lamba 105 dB - Boy 3 - IP66 <b>Turuncu, Sarı, Kırmızı, Şeffaf</b>	24 V AC/DC	876 76C 405		423,00
			110-120 V AC	876 76C 310		444,00
			230-240 V AC	876 76C 313		443,00
		Işıklı Buzzerli Çoklu Çakar Lamba 105 dB - Boy 3 - IP66 <b>Mavi, Yeşil</b>	24 V AC/DC	876 76C 405		457,00
			110-120 V AC	876 76C 310		493,00
			230-240 V AC	876 76C 313		493,00
<b>Buzzerli Lamba "Q" Boy 4</b>				<b>Gövde Kırmızı</b>		
	<b>QSX</b>	LED ışıklı buzzerli sabit / Flaşörlü 105 dB - Boy 4 - IP66 <b>Turuncu, Kırmızı, sarı, şeffaf</b>	24 V AC/DC	876 46C 405		695,00
			110-120 V AC	876 46C 310		704,00
			230-240 V AC	876 46C 313		704,00
		LED ışıklı buzzerli sabit / Flaşörlü 105 dB - Boy 4 - IP66 <b>Mavi, Yeşil</b>	24 V AC/DC	876 46C 405		763,00
			110-120 V AC	876 46C 310		794,00
			230-240 V AC	876 46C 313		794,00
	<b>QCX</b>	LED ışıklı buzzerli çoklu çakar 105 dB - Boy 4 - IP66 <b>Turuncu, Kırmızı, sarı, şeffaf</b>	24 V AC/DC	876 86C 405		704,00
			110-120 V AC	876 86C 310		715,00
			230-240 V AC	876 86C 313		715,00
		LED ışıklı buzzerli çoklu çakar 105 dB - Boy 4 - IP66 <b>Mavi, Yeşil</b>	24 V AC/DC	876 86C 405		772,00
			110-120 V AC	876 86C 310		803,00
			230-240 V AC	876 86C 313		803,00
<b>Aksesuarlar Çok Sesli Siren "A" Lamba "Q"</b>						
	<b>AMK</b>	Montaj kiti	f Çok sesli alıcılar "A" ve/veya Sinyal ışığı "Q" kombinasyonları için	874 010 900		10,00
	<b>AG1</b>	Düz Conta Boy 1	Çok sesli alıcılar "A" ve/veya Sinyal ışığı "Q"	874 021 900		15,00
	<b>AG2</b>	Düz Conta Boy 2	Çok sesli alıcılar "A" ve/veya Sinyal ışığı "Q"	874 022 900		17,00
	<b>AG3</b>	Düz Conta Boy 3	Çok sesli alıcılar "A" ve/veya Sinyal ışığı "Q"	874 023 900		19,00
	<b>AG4</b>	Düz Conta Boy 4	Çok sesli alıcılar "A" ve/veya Sinyal ışığı "Q"	874 024 900		21,00
	<b>AB1</b>	Metal bağlantı kiti Boy 1	Çok sesli alıcılar "A" ve/veya Sinyal ışığı "Q"	874 031 900		30,00
	<b>AB2</b>	Metal bağlantı kiti Boy 2	Çok sesli alıcılar "A" ve/veya Sinyal ışığı "Q"	874 032 900		34,00
	<b>AB3</b>	Metal bağlantı kiti Boy 3	Çok sesli alıcılar "A" ve/veya Sinyal ışığı "Q"	874 033 900		61,00
	<b>AB4</b>	Metal bağlantı kiti Boy 4	Çok sesli alıcılar "A" ve/veya Sinyal ışığı "Q"	874 034 900		69,00
	<b>AKV</b>	Bez kablo M20x1,5	Çok sesli alıcılar "A" ve/veya Sinyal ışığı "Q"	698 800 026		6,00
	<b>AW1</b>	Paslanmaz Çelik Köşebent	Çok sesli alıcılar "A" ve/veya Sinyal ışığı "Q"	874 041 900		32,00





Tip	Model	Açıklama	Teknik Özellikler	Sip. No.	Sip. No.	Fiyat(€)
<b>Konili Mini Korna Sabit Işık</b>				<b>Gri Gövde</b>		
	<b>KLL</b>	Konili Mini Korna-Sabit Işık 92 dB - IP43	24 V DC <b>turuncu</b>	710 111 005		69,00
			24 V DC <b>kırmızı</b>	710 112 005		69,00
			24 V DC <b>sarı</b>	710 117 005		69,00
			24 V AC/50 Hz <b>turuncu</b>	710 111 105		67,00
			24 V AC/50 Hz <b>kırmızı</b>	710 112 105		67,00
			24 V AC/50 Hz <b>sarı</b>	710 117 105		67,00
			48 V AC/50 Hz <b>turuncu</b>	710 111 108		67,00
			48 V AC/50 Hz <b>kırmızı</b>	710 112 108		67,00
			48 V AC/50 Hz <b>sarı</b>	710 117 108		67,00
			230 V AC/50 Hz <b>turuncu</b>	710 111 113		67,00
			230 V AC/50 Hz <b>kırmızı</b>	710 112 113		67,00
			230 V AC/50 Hz <b>sarı</b>	710 117 113		67,00
	<b>KDL</b>	Konisiz Mini Korna-Sabit Işık 92 dB - IP43	24 V DC <b>turuncu</b>	710 011 005		68,00
			24 V DC <b>kırmızı</b>	710 012 005		68,00
			24 V DC <b>sarı</b>	710 017 005		68,00
			24 V AC/50 Hz <b>turuncu</b>	710 011 105		65,00
			24 V AC/50 Hz <b>kırmızı</b>	710 012 105		65,00
			24 V AC/50 Hz <b>sarı</b>	710 017 105		65,00
			48 V AC/50 Hz <b>turuncu</b>	710 011 108		65,00
			48 V AC/50 Hz <b>kırmızı</b>	710 012 108		65,00
			48 V AC/50 Hz <b>sarı</b>	710 017 108		65,00
			120 V AC/60 Hz <b>turuncu</b>	710 011 210		65,00
			230 V AC/50 Hz <b>turuncu</b>	710 011 113		65,00
			230 V AC/50 Hz <b>kırmızı</b>	710 012 113		65,00
230 V AC/50 Hz <b>sarı</b>	710 017 113		65,00			
	<b>KLF</b>	Konili Mini Korna-Çakan Flaş Işık 92 dB - IP43	24 V DC <b>turuncu</b>	710 121 005		105,00
			24 V DC <b>kırmızı</b>	710 122 005		105,00
			24 V DC <b>sarı</b>	710 127 005		105,00
			230 V AC/50 Hz <b>turuncu</b>	710 121 113		94,00
			230 V AC/50 Hz <b>kırmızı</b>	710 122 113		94,00
			230 V AC/50 Hz <b>sarı</b>	710 127 113		94,00
	<b>KDF</b>	Konisiz Mini Korna-Çakan Flaş Işıklı 92 dB - IP43	24 V DC <b>turuncu</b>	710 021 005		104,00
			24 V DC <b>kırmızı</b>	710 022 005		104,00
			24 V DC <b>sarı</b>	710 027 005		104,00
			230 V AC/50 Hz <b>turuncu</b>	710 021 113		92,00
			230 V AC/50 Hz <b>kırmızı</b>	710 022 113		92,00
			230 V AC/50 Hz <b>sarı</b>	710 027 113		92,00

# OPTİK - AKUSTİK SİNYALLER





Tip	Model	Açıklama	Teknik Özellikler	Sip. No.	Sip. No.	Fiyat(€)	
<b>Düzem montaj Buzzerı- LED Kontrol uyarı ışığı Ø22,5mm</b>				<b>Gri Gövde</b>	<b>Siyah Gövde</b>		
<b>Ton / Işık Senkronizasyonu</b>							
	<b>ELG</b>	Q22m LED pano kapağına montaj, Q65mm sabit yada Yanıp-Sönen Buzzer'lı İkaz ışığı <b>Turuncu, Sarı, Kırmızı</b> 103 dB - IP65	12 V AC/DC	814 11C 404	814 51C 404	95,00	
			24 V AC/DC	814 11C 405	814 51C 405	95,00	
			110/120 V AC	814 11C 310	814 51C 310	104,00	
			230/240 V AC	814 11C 313	814 51C 313	104,00	
			LED pano kapağına montaj 65mm sabit yada Yanıp-Sönen Buzzer'lı İkaz Işığı <b>Mavi, Şeffaf, Yeşil</b> 103 dB - IP65	12 V AC/DC	814 11C 404	814 51C 404	109,00
				24 V AC/DC	814 11C 405	814 51C 405	109,00
				110/120 V AC	814 11C 310	814 51C 310	117,00
				230/240 V AC	814 11C 313	814 51C 313	117,00
	<b>ELM</b>	LED pano kapağına montaj, 45mmsabit yada Yanıp-Sönen Buzzer'lı İkaz Işığı <b>Turuncu, Sarı, Kırmızı</b> 98 dB - IP65	12 V AC/DC	813 11C 404	813 51C 404	74,00	
			24 V AC/DC	813 11C 405	813 51C 405	74,00	
			110/120 V AC	813 11C 310	813 51C 310	83,00	
			230/240 V AC	813 11C 313	813 51C 313	83,00	
			LED pano kapağına montaj, 45mmsabit yada Yanıp-Sönen Buzzer'lı İkaz Işığı <b>Mavi, Şeffaf, Yeşil</b> 98 dB - IP65	12 V AC/DC	813 11C 404	813 51C 404	84,00
				24 V AC/DC	813 11C 405	813 51C 405	84,00
				110/120 V AC	813 11C 310	813 51C 310	91,00
				230/240 V AC	813 11C 313	813 51C 313	91,00
<b>Çakan uyarı ışığı Sinyal alıcı</b>					<b>Siyah Gövde</b>		
	<b>VS4</b>	Duyulabilir sinyal alıcı	230/240 V AC		410 40C 005	748,00	
		813 11C 313					
		Renkler : <b>C</b> : 1=Turuncu; 2=Kırmızı; 4=Şeffaf; 5=Mavi; 6=Yeşil; 7= Sarı					



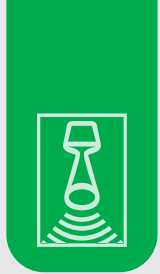

















# AKUSTİK KORNALAR





Tip	Model	Açıklama	Teknik Özellikler	Sip. No.	Sip. No.	Fiyat(€)
<b>Mini Korna</b>				<b>Gri Gövde</b>		
	<b>KLH</b>	Mini Korna Konili 92 dB IP44	12 V DC	710 100 004		37,00
			24 V DC	710 100 005		37,00
			110 V DC	710 100 010		37,00
			220 V DC	710 100 013		37,00
			24 V AC, 50 Hz	710 100 105		34,00
			48 V AC, 50 Hz	710 100 108		34,00
			110 V AC, 50 Hz	710 100 110		34,00
			230 V AC, 50 Hz	710 100 113		34,00
	<b>KDH</b>	Mini Korna Konisiz 92 dB IP44	12 V DC	710 000 004		37,00
			24 V DC	710 000 005		37,00
			110 V DC	710 000 010		37,00
			220 V DC	710 000 013		37,00
			24 V AC, 50 Hz	710 000 105		34,00
			48 V AC, 50 Hz	710 000 108		34,00
			110 V AC, 50 Hz	710 000 110		34,00
			230 V AC, 50 Hz	710 000 113		34,00
<b>Sinyal kornaları</b>				<b>Gri Gövde</b>		
	<b>HPT</b>	Uyarı kornası 108 dB - IP54	24 V DC	712 100 005		135,00
			110 V DC	712 100 010		135,00
			220 V DC	712 100 013		135,00
			24 V AC, 50 Hz	712 100 105		104,00
			48 V AC, 50 Hz	712 100 108		104,00
			110 V AC, 50 Hz	712 100 110		104,00
			230 V AC, 50 Hz	712 100 113		104,00
			120 V AC, 60 Hz	712 100 211		104,00
			240 V AC, 60 Hz	712 100 213		104,00
<b>Sinyal kornaları</b>				<b>Koyu Gri Gövde</b>		
	<b>HTG</b>	Endüstriyel Korna 108 dB - IP65	24 V DC	713 100 005		245,00
			110 V DC	713 100 010		245,00
			220 V DC	713 100 013		245,00
			24 V AC, 50 Hz	713 100 105		212,00
			48 V AC, 50 Hz	713 100 108		212,00
			110 V AC, 50 Hz	713 100 110		212,00
			230 V AC, 50 Hz	713 100 113		212,00
			120 V AC, 60 Hz	713 100 211		212,00
			240 V AC, 60 Hz	713 100 214		212,00
<b>Ziller</b>				<b>Gri Gövde</b>	<b>Kırmızı Gövde</b>	
	<b>UWS FWS</b>	Gemilere Özel Deniz Suyuna ve Korozyona Karşı Korumalı Endüstriyel Korna	12 V DC	720 000 004	720 200 004	182,00
			24 V DC	720 000 005	720 200 005	182,00
			24 V AC	720 000 305	720 200 305	168,00
			48 V AC	720 000 308	720 200 308	168,00
			230 V AC	720 000 313	720 200 313	168,00



Tip	Model	Açıklama	Teknik Özellikler	Sip. No.	Sip. No.	Fiyat(€)
<b>Elektronik Ses Yükseticisi</b>				<b>Kırmızı Gövde</b>	<b>Beyaz Gövde</b>	
	<b>ES1</b>	Çok Sesli Elektronik Siren 32 ton farklı ses 106 dB	24 V DC, 32 tones	C110 620 005	C110 220 005	65,00
	<b>ES2</b>		110 - 230 V AC, 32 tones	C115 600 113	C115 200 113	133,00
<b>Çok Sesli Alarm "A"</b>				<b>Kırmızı Gövde</b>		
	<b>ASS-P</b>	Elektronik siren 8 Farklı Ses Boy 1 103 dB IP66	24 V AC/DC	874 060 405		79,00
			48 V AC/DC	874 060 408		79,00
			110/120 V AC	874 060 310		99,00
			230/240 V AC	874 060 313		99,00
	<b>ASS-T</b>	Elektronik siren, 32 Farklı Ses Boy 1 108 dB IP66	24-48 V AC/DC	874 170 408		101,00
			110-240 V AC	874 170 313		127,00
	<b>ASM</b>	Elektronik Siren 32 Farklı Ses Boy 2 113 dB IP66	24-48 V AC/DC	874 270 408		136,00
			110-240 V AC	874 270 313		173,00
	<b>ASL</b>	Elektronik Siren 63 Farklı Ses Boy 3 120 dB IP66	24-48 V AC/DC	874 360 408		311,00
			110/120 V AC	874 360 310		322,00
			230/240 V AC	874 360 313		322,00
	<b>ASX</b>	Elektronik Siren 63 Farklı Ses Boy 4 127 dB IP66	24-48 V AC/DC	874 460 408		515,00
			110/120 V AC	874 460 310		610,00
			230/240 V AC	874 460 313		610,00
<b>Aksesuarlar Çok Sesli Alarm "A"</b>						
	<b>AMK</b>	Montaj kiti	f Çok sesli alıcılara "A" ve/veya Sinyal ışığı "Q" kombinasyonları için	874 010 900		10,00
	<b>AG1</b>	Düz Conta Boy 1	Çok sesli alıcılara "A" ve/veya Sinyal ışığı "Q"	874 021 900		15,00
	<b>AG2</b>	Düz Conta Boy 2	Çok sesli alıcılara "A" ve/veya Sinyal ışığı "Q"	874 022 900		17,00
	<b>AG3</b>	Düz Conta Boy 3	Çok sesli alıcılara "A" ve/veya Sinyal ışığı "Q"	874 023 900		19,00
	<b>AG4</b>	Düz Conta Boy 4	Çok sesli alıcılara "A" ve/veya Sinyal ışığı "Q"	874 024 900		21,00
	<b>AB1</b>	Metal bağlantı kiti Boy 1	Çok sesli alıcılara "A" ve/veya Sinyal ışığı "Q"	874 031 900		30,00
	<b>AB2</b>	Metal bağlantı kiti Boy 2	Çok sesli alıcılara "A" ve/veya Sinyal ışığı "Q"	874 032 900		34,00
	<b>AB3</b>	Metal bağlantı kiti Boy 3	Çok sesli alıcılara "A" ve/veya Sinyal ışığı "Q"	874 033 900		61,00
	<b>AB4</b>	Metal bağlantı kiti Boy 4	Çok sesli alıcılara "A" ve/veya Sinyal ışığı "Q"	874 034 900		69,00
	<b>AKV</b>	Bez kablo M20x1,5	Çok sesli alıcılara "A" ve/veya Sinyal ışığı "Q"	698 800 026		6,00
	<b>AW1</b>	Paslanmaz Çelik Köşebent	Çok sesli alıcılara "A" ve/veya Sinyal ışığı "Q"	874 041 900		32,00



Tip	Model	Açıklama	Teknik Özellikler	Sip. No.	Sip. No.	Fiyat(€)
<b>Elektronik Buzzerler</b>				<b>Gri Gövde</b>	<b>Siyah Gövde</b>	
	<b>ESG</b>	Ø22mm Pano kapağına montaj Ø65mm sürekli veya kesik kesik çalan Buzzer - 105 bB - IP65	12-24 V AC/DC	814 100 405	814 500 405	79,00
			110/120 V AC	814 100 310	814 500 310	89,00
			230/240 V AC	814 100 313	814 500 313	89,00
	<b>ESM</b>	Ø22mm Pano kapağına montaj Ø45mm sürekli veya kesik kesik çalan Buzzer - 100 bB - IP65	12-24 V AC/DC	813 100 405	813 500 405	49,00
			110/120 V AC	813 100 310	813 500 310	55,00
			230/240 V AC	813 100 313	813 500 313	55,00
	<b>ESK</b>	Panoya montaj Buzzer 30mm Sürekli veya kesik kesik 65 dB - IP65	12-24 V AC/DC	812 100 405	812 500 405	34,00
			110/120 V AC	812 100 310	812 500 310	34,00
			230/240 V AC	812 100 313	812 500 313	34,00
	<b>ESV</b>	Panoya montaj Buzzer 30mm Sürekli veya kesik kesik 85 dB - IP65	12-24 V AC/DC	812 110 405	812 510 405	36,00
			110/120 V AC	812 110 310	812 510 310	36,00
			230/240 V AC	812 110 313	812 510 313	36,00
	<b>WZ30</b>	Adaptör M30.5			812 500 900	12,00
		Anti rotation washer	5 pcs. package	812 300 900		11,00
		Bağlama aleti M22 - 30mm			812 400 900	10,00
<b>Düzlem montajlı Buzzerları Ø28,5mm</b>				<b>Gri Gövde</b>	<b>Siyah Gövde</b>	
	<b>ESD</b>	Piezo Buzzer (daimi-sürekli ton) 90 dB - IP30	24 V AC/DC	810 000 405	810 100 405	25,00
			48 V AC/DC	810 000 408	810 100 408	25,00
			230/240 V AC	810 000 313	810 100 313	30,00
	<b>ESP</b>	Piezo Buzzer (kesik kesik ton) 90 dB - IP30	24 V AC/DC	811 000 405	811 100 405	36,00
			48 V AC/DC	811 000 408	811 100 408	35,00
			230/240 V AC	811 000 313	811 100 313	36,00
	<b>ESZ-S</b>	Piezo Buzzer (daimi-sürekli ve kesik kesik ton) 90 dB - IP30	24 V AC/DC	809 000 405	809 100 405	37,00
			48 V AC/DC	809 000 408	809 100 408	40,00
			110/120 V AC	809 000 310	809 100 310	41,00
	<b>ESZ-K</b>	Piezo Buzzer (daimi-sürekli ve kesik kesik ton) 90 dB - IP30	230/240 V AC	809 000 313	809 100 313	42,00
			24 V AC/DC	809 010 405	809 110 405	42,00
			48 V AC/DC	809 010 408	809 110 408	44,00
			110/120 V AC	809 010 310	809 110 310	46,00
			230/240 V AC	809 010 313	809 110 313	45,00
<b>Panel Mount Buzzers Ø28,5mm</b>					<b>Siyah Gövde</b>	
	<b>BU2</b> <b>BU3</b>	Piezo Buzzer 90 dB - IP54	12 V AC/DC		B100 520 404	14,00
			24 V AC/DC		B100 520 405	14,00
			220 V AC		B100 520 313	14,00
<b>Yüzey montaj Buzzer- Elektronik Siren</b>					<b>Siyah Gövde</b>	
	<b>BU1</b>	Piezo Buzzer/ Elektronik Siren 108 dB - IP66	12 V DC		B100 510 004	29,00
			24 V DC		B100 510 005	29,00



Tip	Model	Açıklama	Teknik Özellikler	Sip. No.	Sip. No.	Fiyat(€)
<b>Elektronik Siren</b>				<b>Tip D</b>	<b>Tip K</b>	
	<b>EHS-D EHS-K</b>	Dip siviç ayarlı 15 ton ses 118db - IP66	12-24 V AC/DC	731 010 405	731 020 405	409,00
			110/120 V AC, 40-60 Hz	731 010 310	731 020 310	409,00
			230/240 V AC, 40-60 Hz	731 010 313	731 020 313	457,00
	<b>EHL-D EHL-K</b>	Dip siviç ayarlı 15 ton ses 110db - IP66	12-24 V AC/DC	730 010 405	730 020 405	363,00
			110/120 V AC, 40-60 Hz	730 010 310	730 020 310	363,00
			230/240 V AC, 40-60 Hz	730 010 313	730 020 313	387,00
<b>Çok Sesli Elektronik Siren</b>			<b>Teknik Özellikler</b>	<b>Sip. No.</b>		<b>Fiyat(€)</b>
	<b>ASML</b>	Çok Sesli Elektronik Siren 15 Farklı Ses 120 dB - IP66  Denizcilik Sektöründe Kullanıma Uygundur.	24 V DC	874 250 005		328,00
<b>Motor Sirenler</b>				<b>Koyu Gri Gövde</b>		<b>Fiyat(€)</b>
	<b>SE1</b>	Motor Siren - Ø110 mm -10 +40 °C 112 dB - IP22	230 V AC/DC	593 004 413		748,00
	<b>SSE12</b>	Koruyucu Başlık		594 001 000		110,00













Auer Signal











# TELEFONLAR













Tip	Model	Açıklama	Teknik Özellikler	Sip. No.	Fiyat(€)
<b>Patlamaya Dayanıklı Telefonlar</b>					
<b>"Ex-Proof" Patlamaya Dayanıklı Analog Telefonlar "ExSafeTel"</b>					<b>Net</b>
 	<b>dST</b>	Patlamaya dayanıklı analog telefon "ExSafeTel" Zone: 1,2,21,22 IP66	Göstergeli / Klavyeli / Zırhlı Siyah	410 010 000	1.599,00
			Göstergeli / Klavyeli / Zırhlı Kırmızı	410 010 100	1.633,00
 	<b>dST</b>	Patlamaya dayanıklı analog acil durum telefonu "ExSafeTel" Zone: 1,2,21,22 IP66	Klavyesiz / Göstergesiz / Zırhlı Siyah	410 020 000	1.559,00
			Klavyesiz / Göstergesiz / Zırhlı Kırmızı	410 020 100	1.599,00
<b>"Ex-Proof" Patlamaya dayanıklı analog telefon"dFT3" - zone 2, 22</b>					<b>Net</b>
	<b>dFT3</b>	Patlamaya Dayanıklı Analog Telefon - 20 + 55 °C - BVS09 Atex E061 95 dB - Zone: 2,22 IP65	Göstergeli / Klavyeli / Zırhlı Kırmızı	410 420 200	1.271,00
	<b>dFT3</b>	Patlamaya Dayanıklı Analog Telefon - 20 + 55 °C - BVS09 Atex E061 95 dB - Zone: 2,22 IP65	Göstergeli / Klavyeli / Zırhlı Kırmızı	410 430 200	1.242,00
	<b>STB</b>	Montaj Aparatı		410 400 900	138,00
<b>Patlamaya dayanıklı telefon aksesuarları</b>					
<b>"Ex-Proof" Patlamaya dayanıklı analog telefon"ExSafeTel"</b>					<b>Net</b>
	<b>AS1</b>	Patlamaya dayanıklı DuyulabilirTelefon çağrı sinyali alıcısı - 90 dB - IP66	Zone: 1, 21 bölgeleri için	410 100 004	679,00
	<b>VS1</b>	Patlamaya dayanıklı Görsel-DuyulabilirTelefon çağrı sinyali alıcısı 90 dB - IP66	Zone: 1, 2 bölgeleri için  Lens rengi C: 1, 2, 4, 5, 6	410 10C 005	1.024,00
	<b>HS1</b>	Patlamaya dayanıklı kulaklık seti		410 100 001	1.104,00
	<b>mTCR</b>	Röle bağlantılı patlamaya dayanıklı telefon	Zone: 1, 21 bölgeleri için	410 100 100	713,00



Tip	Model	Açıklama	Teknik Özellikler	Sip. No.	Fiyat(€)
<b>Zorlu Hava Şartlarına Dayanıklı Analog Telefonlar</b>					
<b>"Weatherproof" Suya dayanıklı analog telefon "SafeTel"</b>					<b>Net</b>
	wST	Suya Dayanıklı Telefon - 25 + 60 °C 90 dB - IP66 - IK09	Klavyeli / Göstergeli / Spiral Kablo Siyah	410 110 000	1.231,00
	wST	Suya Dayanıklı Telefon - 25 + 60 °C 90 dB - IP66 - IK09	Klavyesiz / Göstergesiz / Spiral Kablo Siyah	410 120 000	1.162,00
<b>"Weatherproof" Suya Dayanıklı Analog Telefonlar "wFT3"</b>					<b>Net</b>
	wFT3	Suya Dayanıklı Telefon - 25 + 55 °C 95 dB - IP65	Göstergeli / Klavyeli / Spiral Kablo Sarı	410 300 100	1.047,00
	wFT3	Suya Dayanıklı Telefon - 25 + 55 °C 95 dB - IP65	Göstergesiz / Klavyeli / Spiral Kablo Sarı	410 310 100	1.012,00
	wFT3	Suya Dayanıklı Telefon - 25 + 55 °C 95 dB - IP65	Göstergesiz / Klavyeli / Spiral Kablo Gri	410 310 300	1.024,00
	wFT3	Suya Dayanıklı Telefon - 25 + 55 °C 95 dB - IP65	Göstergeli / Klavyeli / Çelik Spiral Kablo Sarı	410 320 100	1.047,00
	wFT3	Suya Dayanıklı Telefon - 25 + 55 °C 95 dB - IP65	Göstergesiz / Klavyeli / Çelik Spiral Kablo Siyah	410 330 000	1.012,00
	wFT3	Suya Dayanıklı Telefon - 25 + 55 °C 95 dB - IP65	Göstergesiz / Klavyeli / Çelik Spiral Kablo Kırmızı	410 340 200	989,00
	STB	Montaj Aparatı		410 400 900	138,00











Tip	Model	Açıklama	Teknik Özellikler	Sip. No.	Fiyat(€)
<b>"Weatherproof" Su geçirmez analog telefonlar"INDUSTRY"</b>					<b>Net</b>
	<b>wIND</b>	Suya dayanıklı analog telefon 'DUSTRY' -25 + 55 °C - 95dB IP65 (açık) - IP66 (kapalı)	Koruyucu Kapaklı / Klavyeli Sarı	410 700 100	851,00
	<b>wIND</b>	Suya dayanıklı analog telefon 'DUSTRY' -25 + 55 °C - 95dB IP65 (açık) - IP66 (kapalı)	Transparan Koruyucu Kapaklı / Klavyeli Sarı	410 700 110	840,00
	<b>wIND</b>	Suya dayanıklı analog telefon 'DUSTRY' -25 + 55 °C - 95dB IP65 (açık) - IP66 (kapalı)	Koruyucu Kapaklı Sarı	410 710 100	828,00
	<b>wIND</b>	Suya dayanıklı analog telefon 'DUSTRY' -25 + 55 °C - 95dB IP65 (açık) - IP66 (kapalı)	Transparan Koruyucu Kapaklı Sarı	410 710 110	817,00
	<b>wIND</b>	Suya dayanıklı analog telefon 'DUSTRY' -25 + 55 °C - 95dB IP65 (açık) - IP66 (kapalı)	Transparan Koruyucu Kapaklı / Klavyeli LED Çağrı Göstergeli Sarı	410 700 200	920,00
<b>Suya dayanıklı telefonlar için malzemeler</b>					<b>Net</b>
	<b>VS2</b>	Patlamaya dayanıklı Görsel-duyulabilir Çağrı sinyal alıcı	Lens rengi C: 1, 2, 4, 5, 6	410 20C 005	725,00
	<b>HS2</b>	Patlamaya dayanıklı kulaklık seti		410 200 001	943,00
	<b>TCR</b>	Yanmaya dayanıklı telefon bağlama röle seti	1, 21 bölgesi için	410 100 200	426,00
	<b>TH1</b>	Telefon koruma başlığı TH1	Metal, sarı	410 100 006	1.587,00
			GRP, turuncu	410 100 007	1.610,00
			PVC, turuncu	410 100 013	1.449,00



# EX-PROOF SINYAL EKİPMANLARI

ATEX  





Tip	Model	Açıklama	Teknik Özellikler	Sip. No.	Fiyat(€)
<b>"Ex-Proof" Sinyal Kornaları</b>					<b>Net</b>
	<b>mHPT</b>	Patlamaya dayanıklı Sinyal kornası Sıcaklık menzili T5 -20 + 60 °C - 108 dB Zone: 1,2 - IP54	24 V DC	301 100 005	632,00
			115 V AC	301 100 110	580,00
			230 V AC	301 100 113	580,00
	<b>mHTG</b>	Patlamaya dayanıklı Sinyal Metalkorna, -55 + 60 °C - 108 dB Zone: 1,2,21,22 - IP66	24 V DC	302 100 005	706,00
			230 V AC	302 100 113	667,00
	<b>dHH</b>	Ex-proof Sinyal Korna -20 + 75 °C - 105 dB Zone: 1,2,21,22 - IP66	230 V AC, 50 Hz	300 000 113	909,00
			240 V AC, 60 Hz	300 000 213	909,00
			24 V DC	300 000 005	909,00
			220 V DC	300 000 013	909,00
	<b>dHW</b>	Patlamaya dayanıklı Sinyal Korna -20 + 60 °C - 105 dB Zone: 1,2,21,22 - IP66	230 V AC, 50 Hz	320 000 113	1.001,00
			24 V DC	320 000 005	1.001,00
<b>"Ex-Proof" Patlamaya dayanıklı elektronik alıcılar</b>					<b>Net</b>
	<b>dMS</b>	Patlamaya dayanıklı çok sesli elektronik siren 32 Farklı Ses - 115 dB -50 + 60 °C - PTB 14 Atex 1005 Zone: 1,2,21,22 - IP66	85 - 265 V AC	371 000 313	1087,00
	<b>dMS</b>		24 V DC	371 000 005	1047,00
	<b>MK-dMS</b>	Titreşim uygulamaları için montaj kiti		371 000 900	311,00
	<b>dHE1</b>	Patlamaya dayanıklı elektronik alıcı	85 - 265 V AC	370 000 000	1.323,00
	<b>dHE2</b>		21,6 - 75 V DC	370 000 001	1.323,00

Tip	Model	Açıklama	Teknik Özellikler	Sip. No.	Fiyat(€)
<b>"Ex-Proof" Patlamaya dayanıklı çakan lambalar</b>					<b>Net</b>
	dSF	Xenon çakar ışık - Ø 110 mm Tüm modelleri koruma kafesi Patlamaya dayanıklı -55 + 55 °C Zone: 1,2,21,22 - IP66 Turuncu, Kırmızı, Mavi, Yeşil, Sarı, Şeffaf	110/120 V AC, 50-60 Hz, 5 J	335 10C 410	915,00
			110/120 V AC 50-60 Hz, 15 J	335 00C 410	1.007,00
			230/240 V AC, 50-60 Hz, 5 J	335 10C 413	903,00
			230/240 V AC, 50-60 Hz, 15 J	335 00C 413	978,00
			24 V DC, 5 J	335 10C 005	897,00
			24 V DC, 15 J	335 00C 005	978,00
<b>"Ex-Proof" Patlamaya dayanıklı LED-Sinyal lambaları</b>					<b>Net</b>
	dSD	LED çakar ışık - Ø 110 mm Tüm modelleri koruma kafesi Patlamaya dayanıklı -55 + 55 °C Zone: 1,2,21,22 - IP66, IP67	110 - 240 V AC koruyucu kafesli Kırmızı, Sarı	335 21C 313	1.380,00
			110 - 240 V AC koruyucu kafesli Yeşil, Mavi, Şeffaf	335 21C 313	1.415,00
			24 V DC koruyucu kafesli Kırmızı, Sarı	335 21C 005	1.265,00
			24 V DC koruyucu kafesli Yeşil, Mavi, Şeffaf	335 21C 005	1.277,00
			48 V DC koruyucu kafesli Kırmızı, Mavi, Yeşil, Sarı, Şeffaf	335 21C 008	1.265,00
<b>"Weatherproof" Elektromekanik Zil</b>					<b>Net</b>
  	BEL	Weatherproof Elektromekanik Zil Duvar Montaj 106 dB - IP66 -25 +50 °C - Ø 110 mm	24 V DC Kırmızı	720 400 005	202,00
			12 V DC Gri	720 300 004	202,00
			24 V AC Gri	720 300 305	202,00
			24 V DC Gri	720 300 005	202,00
			115 V AC Gri	720 300 310	202,00
			230 V AC Gri	720 300 313	202,00

Tip	Model	Açıklama	Teknik Özellikler	Sip. No.	Fiyat(€)
<b>"Ex-Proof" Patlamaya dayanıklı LED Sinyal uyarı ışığı</b>					<b>Net</b>
	<b>mDD</b>	Patlamaya dayanıklı LED- Sinyal uyarı ışığı -40 + 60 °C - Ø 103 mm Zone: 1,2,21,22 - IP66	230 V AC	336 00C 413	1.001,00
			24 V DC	336 00C 005	805,00
<b>"Ex-Proof" Patlamaya dayanıklı LED çok renkli lambalar</b>					<b>Net</b>
	<b>mMD</b>	Patlamaya dayanıklı Çok renkli LED- Sinyal uyarı ışığı -20 + 50 °C - Ø 103 mm Zone: 2,22 - IP66	230 V AC	337 000 313	685,00
			24 V DC	337 000 005	656,00
<b>"Ex-Proof" dSF, dSD, mDD, mMD, dMS ürünleri için malzemeler</b>					<b>Net</b>
	<b>MPL</b>	dSF, dSD, mDD, mMD, dMS kombinasyonları için monteleme düzlemi	Paslanmaz çelik, patlamaya dayanıklı kutu	335 500 000	641,00

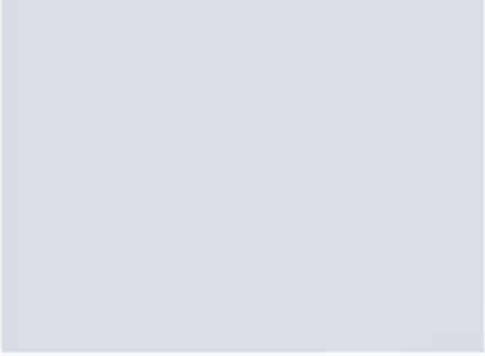

# AKSESUARLAR





Tip	Model	Açıklama	Teknik Özellikler	Sip. No.	Fiyat(€)
<b>LED Lambalar</b>					
	LLL	LED Sabit Yanan Işık - Sarı, Kırmızı	12 V AC/DC	893 00C 404	27,00
			24 V AC/DC	893 00C 405	27,00
			48 V AC/DC	893 00C 408	27,00
			110/120 V AC	893 00C 310	27,00
			230/240 V AC	893 00C 313	27,00
	LED Sabit Yanan Işık - Mavi, Şeffaf, Yeşil	12 V AC/DC	893 00C 404	38,00	
		24 V AC/DC	893 00C 405	38,00	
		48 V AC/DC	893 00C 408	38,00	
		110/120 V AC	893 00C 310	38,00	
		230/240 V AC	893 00C 313	38,00	
	LLB	LED Flaşör-Yanıp Sönen Işık - Sarı, Kırmızı	12 V AC/DC	893 01C 404	32,00
			24 V AC/DC	893 01C 405	32,00
			48 V AC/DC	893 01C 408	32,00
			110/120 V AC	893 01C 310	32,00
			230/240 V AC	893 01C 313	32,00
	LED Flaşör-Yanıp Sönen Işık - Mavi, Şeffaf, Yeşil	12 V AC/DC	893 01C 404	44,00	
		24 V AC/DC	893 01C 405	44,00	
		48 V AC/DC	893 01C 408	44,00	
		110/120 V AC	893 01C 310	48,00	
		230/240 V AC	893 01C 313	48,00	
LED rengi C: 1, 2, 4, 5, 6, 7					
893 01C 313					
Renkler : C : 1=Turuncu; 2=Kırmızı; 4=Şeffaf; 5=Mavi; 6=Yeşil; 7=Sarı					



Tip	Model	Açıklama	Teknik Özellikler	Sip. No.	Fiyat(€)	
<b>Ampül-Halojen ampül-Xenon tüp</b>						
	GL01	Ampul(BA 15 d)	12 V, 5 W	890 010 904	4,00	
	GL02		24 V, 6,5 W	890 010 905	4,00	
	GL03		48 V, 5 W	890 010 908	4,00	
	GL04		60 V, 7 W	890 010 909	4,00	
	GL05		110-120 V, 7 W	890 010 910	4,00	
	GL06		230-240 V, 6 W	890 010 913	4,00	
	GL11	Ampul(BA 15 d)	12 V, 4 W	890 012 904	4,00	
	GL12		24 V, 4 W	890 012 905	4,00	
	GL13		48 V, 4 W	890 012 908	4,00	
	GL14		60 V, 4 W	890 012 909	4,00	
	GL15		110-120 V, 4 W	890 012 910	4,00	
	GL16		230-240 V, 4 W	890 012 913	4,00	
	GL21	Ampul(BA 15 d)	12 V, 25 W	890 025 904	7,00	
	GL22		24 V, 25 W	890 025 905	7,00	
	GL23		48 V, 25 W	890 025 908	7,00	
	GL24		60 V, 25 W	890 025 909	7,00	
	GL25		110-120 V, 25 W	890 025 910	7,00	
	GL26		230-240 V, 25 W	890 025 913	7,00	
	HL51	Halojen Ampul (for MLL-MBL-MRL)	12 V, 50 W, GY 6.35	890 050 904	9,00	
	HL52		24 V, 50 W, GY 6.35	890 050 905	9,00	
	HL55		110/120 V, 50 W, G 6.35	890 050 910	11,00	
	HL56		230/240 V, 50 W, G 6.35	890 050 913	11,00	
	HL31	Halojen Ampul (for MLM-MBM-MRM)	12 V, 35 W, GY 6.35	890 035 904	9,00	
	HL32		24 V, 35 W, GY 6.35	890 035 905	9,00	
	HL35		110/120 V, 35 W, G 6.35	890 035 910	11,00	
	HL36		230/240 V, 35 W, G 6.35	890 035 913	11,00	
	HL21	Halojen Ampul (for MLS-MBS-MRS)	12 V, 20 W, GY 6.35	890 020 904	9,00	
	HL22		24 V, 20 W, GY 6.35	890 020 905	9,00	
	HL25		110/120 V, 20 W, G 6.35	890 020 910	11,00	
	HL26		230/240 V, 20 W, G 6.35	890 020 913	11,00	
	XT30	Xenon Tüp	30 J (MFL)	890 130 900	26,00	
	XT15		15 J (MFM)	890 115 900	21,00	
	XT07		7 J (MFS)	890 107 900	21,00	







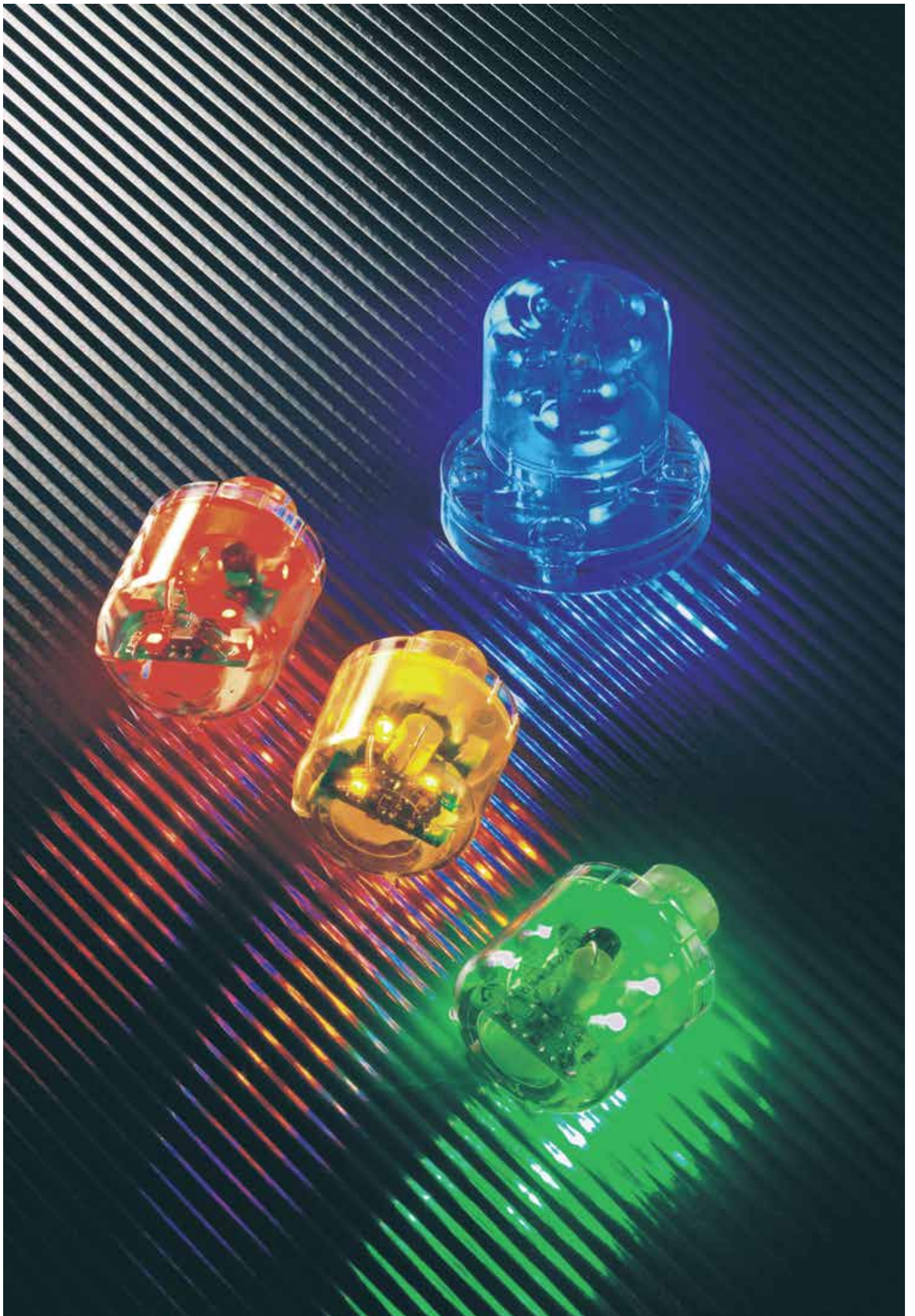

# Ex-Proof & Weather-proof

Visual signalling  
equipment



Audible signalling  
equipment



Explosion-proof



Weather-proof



Visual signalling equipment



Audible signalling equipment



**ESEN**  
Elektrik San. ve Tic. Ltd. Şti

**MERKEZ :** Perpa Ticaret Merkezi A Blok Kat 11 No: 1488 34384 Okmeydanı - Şişli - İSTANBUL  
Tel : (0212) 222 94 16 (pbx) Fax : (0212) 222 94 17

**ÜRETİM :** O.S.B. Birlik Sanayi Sitesi 1. Cd. No.26 Beylikdüzü - İSTANBUL  
Tel : (0212) 222 94 16 (pbx) Fax : (0212) 222 94 17

esen@esen.com.tr • www.esen.com.tr

